

MHI
Copy 3

1910
FM 8-50

WAR DEPARTMENT

MEDICAL FIELD MANUAL



**SPLINTS, APPLIANCES,
AND BANDAGES**

MEDICAL FIELD MANUAL



SPLINTS, APPLIANCES, AND BANDAGES

Prepared under direction of
The Surgeon General



UNITED STATES
GOVERNMENT PRINTING OFFICE
WASHINGTON : 1940

WAR DEPARTMENT,
WASHINGTON, *September 11, 1940.*

FM 8-50, Medical Field Manual, Splints, appliances, and bandages, is published for the information and guidance of all concerned.

[A. G. 062.11 (6-12-40).]

BY ORDER OF THE SECRETARY OF WAR:

G. C. MARSHALL,
Chief of Staff.

OFFICIAL:

E. S. ADAMS,
*Major General,
The Adjutant General.*

TABLE OF CONTENTS

SECTION I. GENERAL.	Paragraph	Page
Purpose and scope-----	1	1
II. SPLINTING FRACTURES FOR TRANSPORTATION.		
General-----	2	2
Army hinged half-ring thigh and leg splint-----	3	2
Splint strap, adjustable traction----	4	4
Splint support and footrest-----	5	4
Immobilization for transportation of major fractures of lower extremity-----	6	9
Emergency treatment and transportation of fracture of spine-----	7	12
Wire ladder splint-----	8	14
Thomas splint, arm-hinged-----	9	15
Basswood splint-----	10	18
Prevention and early treatment of traumatic shock-----	11	18
III. SPLINTS AND APPLIANCES USED IN DEFINITIVE CARE OF BONE AND JOINT INJURIES.		
General-----	12	20
Definitive treatment of fractures---	13	21
Balkan frame-----	14	22
Skin traction-----	15	27
Steinmann extension apparatus-----	16	29
Skeletal suspension and traction----	17	29
Wire apparatus-----	18	30
Skeletal fixation of proximal and distal fragments-----	19	30
Attachment Pierson-----	20	32
Cabot splint-----	21	35
Aluminum cock-up wrist splint-----	22	37
T-splint for fractured clavicle-----	23	38
Aeroplane or abduction splint-----	24	40
Basswood splint-----	25	42
Plaster of paris-----	26	44
Plaster casts-----	27	45
Pipe frame and hammock for hyper-extension body cast-----	28	46
Compression fractures of spine-----	29	49
Fracture or dislocation of cervical spine-----	30	50
IV. BANDAGES AND DRESSINGS.		
General-----	31	52
Rules for bandaging-----	32	54
Application of bandages and their uses-----	33	55
Dressings-----	34	81
Appendix-----		89

MEDICAL FIELD MANUAL

SPLINTS, APPLIANCES, AND BANDAGES

SECTION I

GENERAL

■ 1. PURPOSE AND SCOPE.—*a.* The purpose of this manual is to place in the hands of the medical officer a guide for instruction of medical personnel in application of bandages, dressings, splints, and appliances. It should enable him to organize his instruction so as to convey information which may be utilized by medical personnel in their various tasks pertaining to care of the surgical patient whenever application of splints, bandages, or dressings is required. Illustrations show bandages, dressings, splints, and appliances and procedure for their application. The illustrations may be transferred onto charts but preferably instruction should be carried out by actual demonstrations. Therefore, this manual serves as a practical time-saving guide for instruction and not as complete information in care and treatment of wounds or fractures. It includes such description and nomenclature of those splints and appliances as will provide adequate treatment and which adhere to designs that meet the following qualifications:

- (1) Efficiency and correct mechanical methods.
- (2) Simplicity of design and low cost of construction.
- (3) Transportability in order that an efficient splint may be applied and remain in situ until the patient reaches the hospital for definitive care. In some instances, changes in type of splint used may not be necessary even at the fixed hospital.
- (4) Quick manufacture and easy distribution.
- (5) Combination of traction and fixation in the same apparatus.
- (6) Constancy of type and simplicity of mechanical procedure making it readily understood and easily applied.

b. Section II deals with splints and appliances such as may be applied by enlisted personnel of the Medical Department

so as to assure fixation and traction, thereby reducing chances of infection and minimizing pain and shock during transportation. Splints and appliances and their application as used in transportation of fractures, including certain splints used in definitive treatment, are illustrated.

c. Section III deals with those splints and appliances used in the definitive care of fractures.

d. Section IV deals with description and use of various types of bandages and dressings.

e. Certain of the splints are standard items of supply, others are nonstandard, and still others are splints and appliances which may be made at a local hospital by using specifications given.

SECTION II

SPLINTING FRACTURES FOR TRANSPORTATION

■ 2. GENERAL.—The necessity for splinting fractures before transportation is attempted cannot be overestimated. It lessens pain, shock, and additional damage to bones and soft parts. Compound fractures are not further contaminated, shortening is prevented, and reduction is made less difficult. The primary mortality rate of 50 percent in compound fractures of the femur in the British Army during the World War was reduced to 15 percent by proper splinting alone. Every major fracture in the long bones should be splinted where they lie before transportation is attempted. Proper splinting of peacetime fractures is equally as essential as care of wartime injuries.

■ 3. ARMY HINGED HALF-RING THIGH AND LEG SPLINT (fig. 1).—*a. Description.*—(1) The side arms of the splint are made of $\frac{3}{8}$ -inch cold rolled or Bessemer steel rod; the half ring of the same material, $\frac{1}{2}$ inch in diameter.

(2) The half ring is covered with an inner layer of $\frac{1}{2}$ -inch felt and an outer layer of $\frac{1}{4}$ -inch felt. The felt is covered with first-cut horsehide, cream color, not oiled or dressed, and free from material that might irritate the skin. The leather is neatly and securely sewed with waxed linen thread, using a baseball stitch (about four to the inch). The covering is so stitched that the surface coming in contact with

the patient is smooth. The finished padded portion is about $1\frac{1}{4}$ inches in diameter. The inner layer of felt stops at the joint, being tapered for a distance of about $1\frac{1}{4}$ inches just above the joint to allow for the thickness of the webbing strap over which it is sewed. The outer layer of felt stops $1\frac{1}{4}$ inches below the joint, the ends being tapered for a distance of approximately 2 inches and cut transversely to permit passage of the webbing strap. The stitching is continuous and is carried through the webbing.

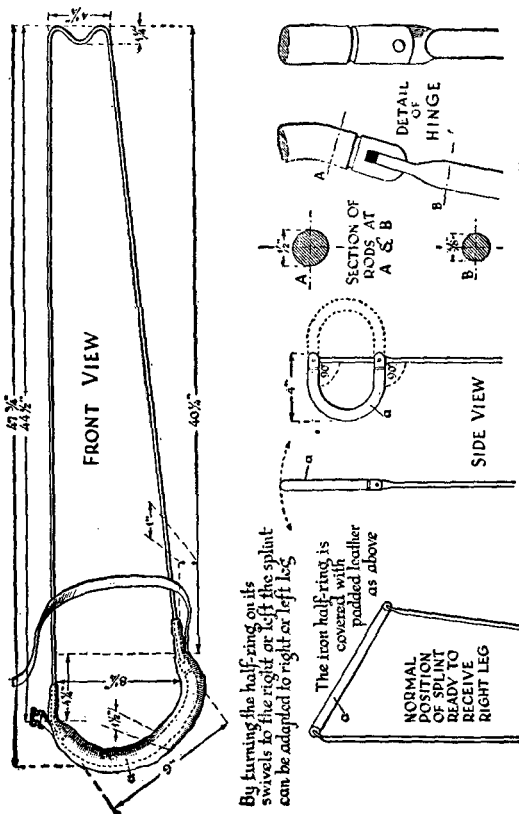

FIGURE 1.—Army hinged half-ring thigh and leg splint

b. Uses.—(1) *Transportation.*—Fixed traction treatment of—

- (a) Fractures of the femur.
- (b) Fractures and injuries of the knee.
- (c) Fractures of the tibia above the ankle.

(2) *Definitive care.*—Suspension traction treatment of—

- (a) Fractures of the femur.
- (b) Fractures of the tibia and fibula.
- (c) Other injuries and orthopedic conditions of the lower extremity.

■ 4. **SPLINT STRAP, ADJUSTABLE TRACTION** (fig. 2).—(Accessory to Army hinged half-ring splint).

a. Description.—The adjustable traction splint strap is made of 1-inch nonelastic webbing. It consists of a main loop, a retention strap with buckle, and an extension strap with swivel. The loop is 14 inches in circumference and is designed to fit over the instep. A 12-inch strap without buckle and a 2½-inch strap with a 1-inch chrome plated nickel steel release buckle are sewed to the loop in a manner which will retain the loop in proper position across the instep when the 12-inch strap is passed back of the ankle and buckled just posterior to the external malleolus. A 40-inch strap attached to the loop by means of a swivel is provided for the purpose of applying extension.

b. Application.—(1) The adjustable traction strap is applied over the shoe of the patient and attached to lower end of the Army hinged half-ring splint to secure fixed traction.

(2) Traction is increased by the Spanish windlass method.

(3) The ankle hitch or Collins hitch (fig. 2 (2)) using a muslin bandage may be used as a substitute.

(4) The shoe should never be removed in the field.

(5) When clothing has been removed, the extremity should be shaved and skin traction applied as shown in figure 12, the rope from the spreader being fixed to the end of the splint to obtain traction.

■ 5. **SPLINT SUPPORT AND FOOTREST** (fig. 3).—Two of these supports are issued with each Army hinged half-ring splint for field use.

a. *Description.*—They are made of ¼-inch cold rolled or Bessemer steel rod. The efficiency of the appliance depends upon its spring; therefore the rod should be worked cold, as heat will remove the temper.

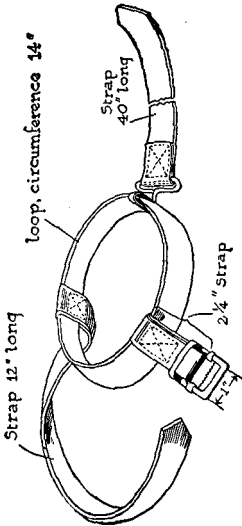
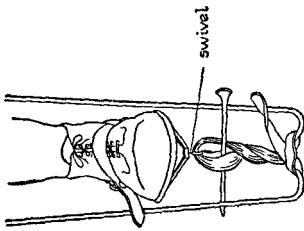

① Strap made of 1-inch nonelastic webbing.

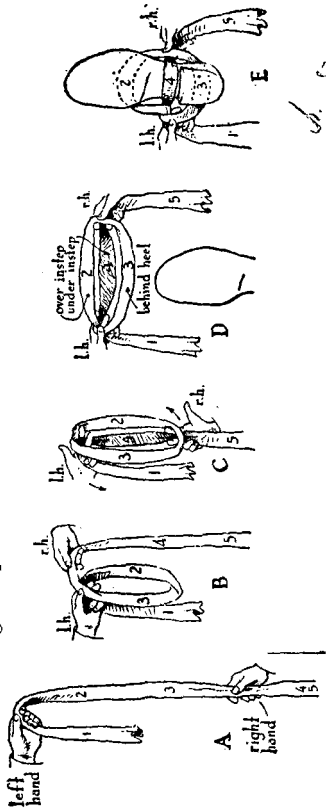

© Ankle hitch using muslin bandage.
FIGURE 2.—Splint strap, adjustable traction.

b. *Uses* (figs. 4 and 5).—(1) One support is attached to the lateral bars of the Army hinged half-ring splint with the arms of the appliance toward the distal end of the splint after the leg has been fixed in the splint. It supports the

distal end of the splint, allowing the leg to be suspended in the splint and preventing it from resting on the ground, litter, or table.

(2) Another is secured in a similar manner with the arms extending upward and to it the foot is secured by a triangular bandage.

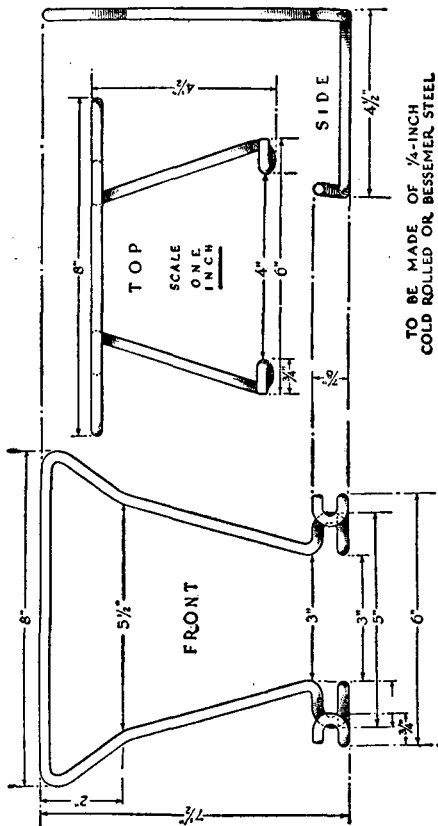

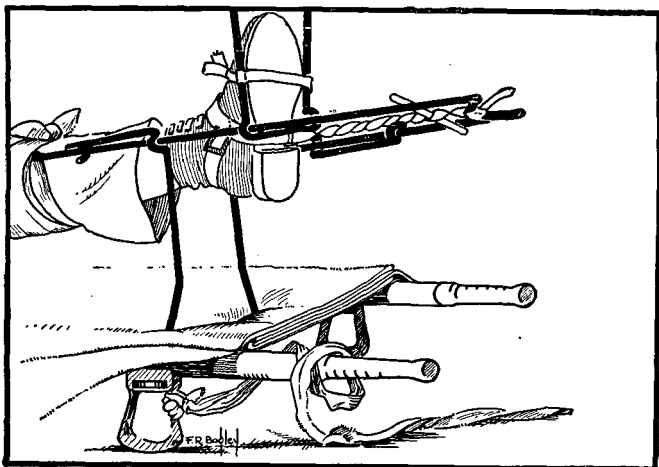

①

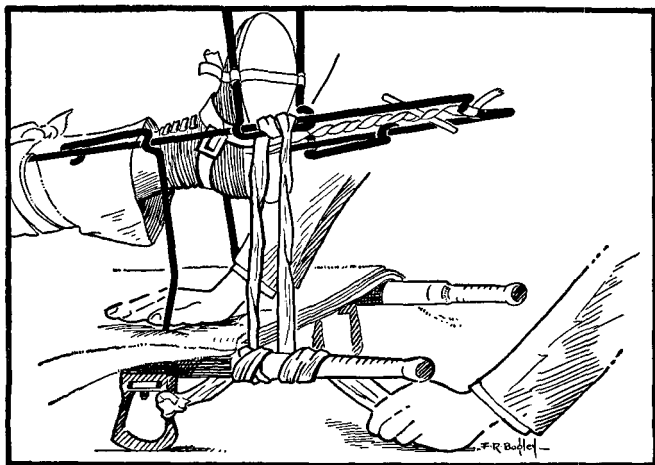

②

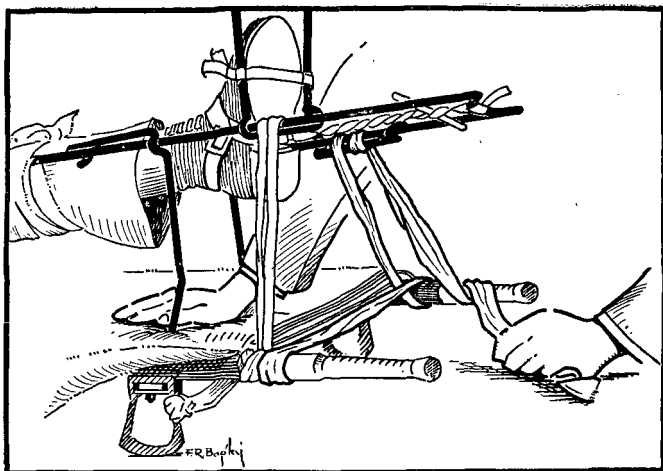

③

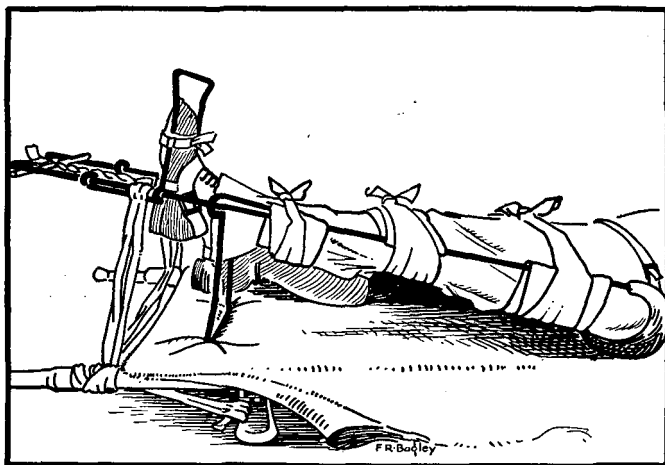

④

FIGURE 4.—Use of bandage for fixation of Army hinged half-ring leg splint for transportation.

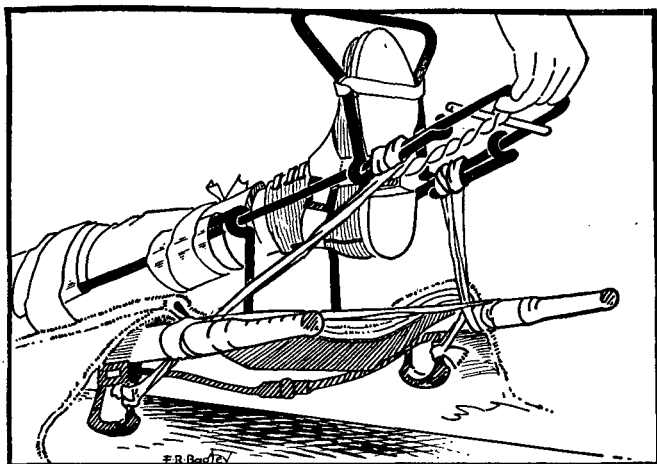

FIGURE 5.—Test of application of fixation of Army hinged half-ring leg splint for transportation.

■ 6. IMMOBILIZATION FOR TRANSPORTATION OF MAJOR FRACTURES OF LOWER EXTREMITY.—*a. General.*—Immobilization of major fractures of the lower extremities for transportation is accomplished by the application of the Army hinged half-ring leg splint applied as described below and as shown in figures 4 and 5.

(1) *In war.*—Articles listed in *b* below are included in equipment for regimental medical detachments, medical battalions, medical squadrons, and medical regiments.

(2) *In peace.*—Each Medical Department ambulance transporting patients and answering emergency calls should at all times carry this equipment. The ambulance driver and orderly should be trained in the application of this splint.

b. Equipment.—Equipment required for the application of each leg splint is as follows:

- (1) One litter, standard wooden pole or aluminum.
- (2) One Army leg splint, hinged half-ring.
- (3) Two footrest and splint supports (new type).

NOTE.—If footrest and splint supports are not available, a splint foot support and a leg rest (old type) may be used.

- (4) One traction strap (fig. 2).
- (5) Two rolls of muslin bandage, 5 inches by 5 yards, and one gauze bandage.
- (6) Three blankets.
- (7) Six safetypins.
- (8) One first-aid packet.

c. Application.—Two men, Privates *A* and *B*, work together in the application of the traction fixation splints for transportation, carrying out the following procedures:

(1) *A* grasps and makes traction on the foot of the patient while *B* applies the traction strap or ankle hitch over the shoe.

(2) While traction is continued by *A*, if the fracture is compound, *B* cuts away clothing about the wound and applies an occlusive dressing (first-aid packet).

(3) While traction is continued by *A*, *B* adjusts the Army hinged half-ring splint (right or left), locking the half ring at a right angle to the bars of the splint, sliding it from the outside inward, the short rod to the inner side of the leg and the half ring well up under the buttock against the tuberosity of the ischium. He then tightens the anterior strap to hold it there.

(4) *B* secures the traction strap to the end of the splint and increases traction by the Spanish windlass method (figs. 4 ① and 5), after which *A* gradually released his traction on the foot.

(5) *A* attaches the splint support to the splint and ties the foot in position against it, using available bandage or binding material.

(6) *B* attaches the footrest to the splint with lower hooks downward and inside the splint rods. The footrest is pushed against the shoe to prevent foot drop. The footrest should be spread, if necessary, for a more secure fit, and secured with bandage to prevent lateral movement of the foot.

d. Fixation of Army hinged half-ring leg splint.—The splint is fixed to the litter in the following manner:

(1) Take a roll of the bias muslin bandage and stretch it to its greatest length. (In emergency, any strong enough binding material may be used.)

(2) Tie one end of bandage to litter stirrup on the side of the fracture, placing knot near the pole. (See fig. 4 ①.) The knot is placed on the stirrup near the pole and bandage wound around the bevel of the handle near edge of canvas to keep bandage from slipping and becoming loose.

(3) Keeping a constant tension on the bandage, carry it to inside of bevel of the handle close to the canvas and wind it around the handle twice. (See fig. 4 ①.)

(4) Carry bandage to near side rod of leg splint, keeping it at a 90° angle (perpendicular) to the splint. Wind bandage around splint rod twice and carry it back and around the same handle of the litter. Then press splint firmly down on litter and continue the constant pull on the bandage so that all slack in the bandage going from the litter to the splint and from the splint back to the litter will be taken up. (See fig. 4 ②.)

NOTE.—The bandage is kept under constant tension as it is applied in order to overcome its elasticity. The small amount of elasticity remaining is considered beneficial. In an emergency, wire, rope, or other binding material may be used for fastening the splint to the handles of the litter.

(5) Carry bandage across the litter to bevel of opposite handle and wind it around twice. (See fig. 4 ③ and ④.)

(6) Secure side rod of splint on the other side just the same as was done on the near side. Finish by tying the bandage to the stirrup. (See fig. 4 ④.)

(7) When the muslin bandage is properly applied and tied, the splinted leg and end of litter can be lifted clear of the ground without loosening the muslin bandage. The position of the splint rest on the blanket and canvas remains unaffected and the bandage is still taut when the end of the litter is again lowered to the ground. (See fig. 5.)

e. Protection of patient during transportation.—After dressing the litter with two blankets, cover patient, fold a third blanket once lengthwise and place it over patient, upper edge under the chin. Next fold the free edges of first two blankets over the third and hold them in place with safetypins. In-close feet of patient by folding lower ends of blankets. (See fig. 6.) This gives four thicknesses of blankets over and four under the patient, thus assisting in prevention of shock.

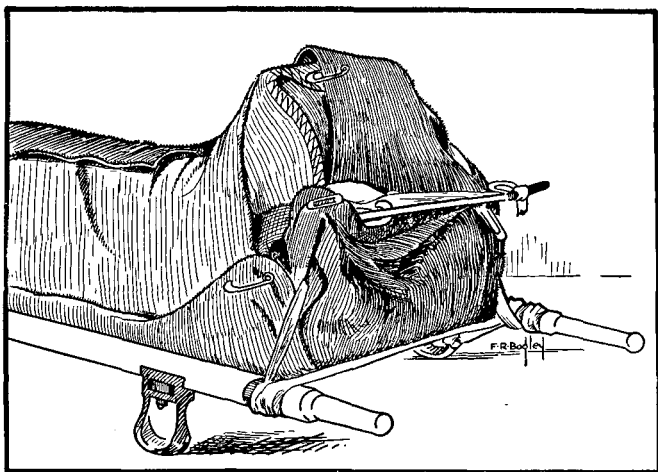

FIGURE 6.—Arrangement of blankets for transportation of patient with Army leg splint applied.

■ 7. EMERGENCY TREATMENT AND TRANSPORTATION OF FRACTURE OF SPINE (fig. 7).—*a.* Moderate extension of the spine is indicated in all suspected compression fractures. Any movement or manipulation of the patient that will flex the spine will further compress the fracture and possibly cause cord damage. Extension may be attained with the patient prone or recumbent. The first objective may be attained by carrying him face downward in a blanket. However, a more positive and more comfortable method of emergency treatment is the recumbent position with two or three pillows or a rolled blanket under the site of fracture.

b. Compression fractures are produced by transmitted force which causes hyperflexion or jackknifing of the spine and it is noted that the procedures above-mentioned reverse the mechanics which produce the injury and thereby prevent further damage.

c. Cervical fractures and dislocations require continuous head traction with moderate extension. Hyperextension in suspected injuries of this area is contra-indicated. Definitive measures will necessarily be predicated on X-ray findings.

INCORRECT: Patient supine on soft structure, position tends to jack-knife the vertebrae causing continued compression.

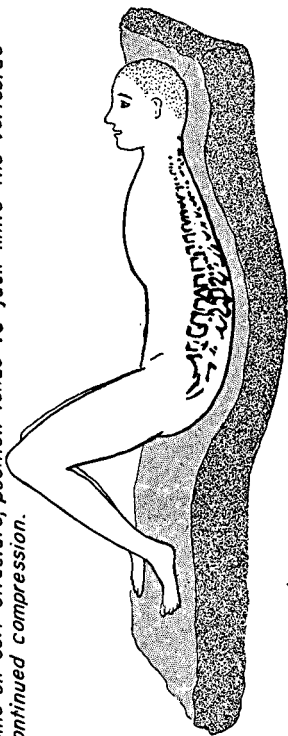

CORRECT: Rolled blanket under the site of fracture, spine in hyperextension.

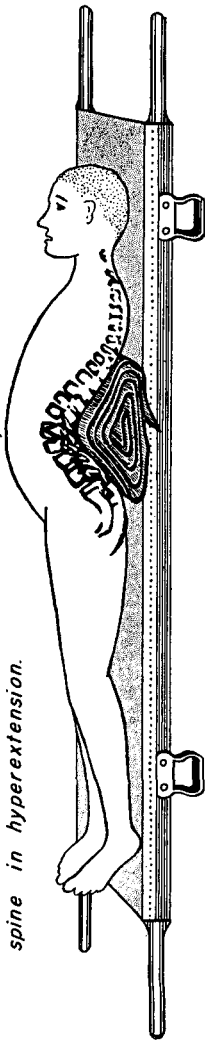

FIGURE 7.—Emergency transportation of fracture of the spine.

■ 8. WIRE LADDER SPLINT (fig. 8).—*a. Construction.*—(1) The frame is made in the form of three sides of a rectangle, $3\frac{1}{2}$ by 31 inches, one short side missing, made of No. 9 B and S gage malleable iron wire.

(2) The crosspieces are made of one continuous piece of No. 15 B and S gage malleable iron wire shaped in the form of a gridiron with paralleled bars about $\frac{5}{8}$ inch apart.

(3) The gridiron section of wire is attached to the frame by tightly wrapping with a malleable iron wire of about No.

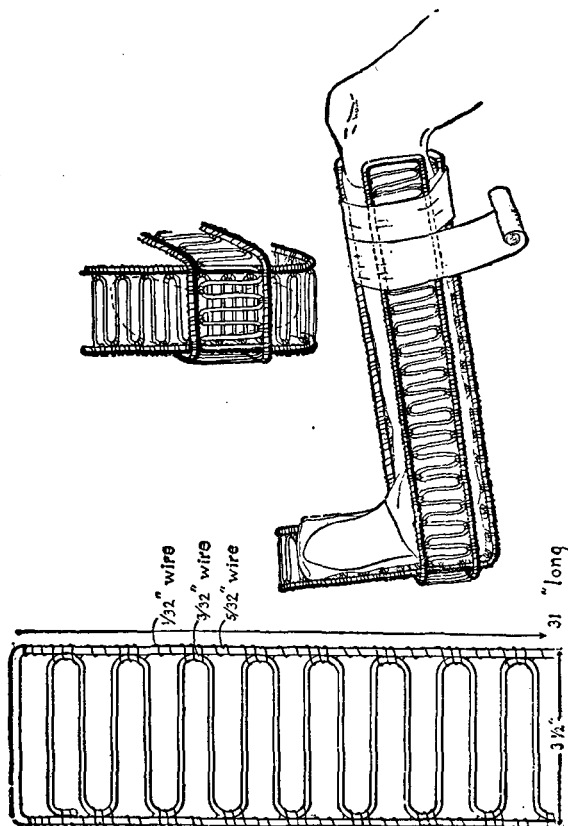

FIGURE 8.—Wire ladder splint.

22 *B* and *S* gage, three turns to each lateral section and two in between. Ends are well wrapped and secured.

(4) Following assembly, the splint is heavily galvanized.

b. Uses.—(1) Splinting for transportation of Pott's fractures, injuries, and fractures about the ankle and foot, gauze cotton pads in peacetime, and first-aid packet, large, in war are used as padding. The splints, when padded and applied, are held in position by a bias muslin bandage.

(2) As coaptation splints in the field or in hospital.

(3) Where a malleable light splint is required for a temporary period, as for the shoulder, elbow, or wrist to maintain a fixed position other than that of extension.

■ 9. THOMAS SPLINT, ARM-HINGED (fig. 9).—*a. Construction.*—

(1) This splint is made of ¼-inch cold rolled or Bessemer steel rod, gray saddle felt, and three pieces of horsehide.

(2) The ring is protected with gray saddle felt covered with first-cut horsehide, cream color, not oiled or dressed, and free from material that might irritate the skin. The leather is neatly and securely sewed with waxed linen thread, using a baseball stitch (about four to the inch). The covering is so stitched that the surface coming in contact with the patient is smooth. The finished padded portion is about 1¼ inches in diameter.

(3) The splint with material for its application forms a part of the battalion, regimental medical detachment, and medical regiment equipment. It should also be carried in each ambulance.

b. Uses.—This splint is used in the treatment of injuries to—

- (1) Shoulder joints.
- (2) Shaft of humerus.
- (3) Elbow joint.
- (4) Upper one-third of forearm.

c. Application, upper extremity.—(1) *A* grasps the hand and makes traction. Traction other than by hand should not be used. *B* determines site of fracture. He removes all clothing to shoulder, and if the fracture is compound, iodizes the wound and applies an occlusive dressing.

(2) *B* applies adhesive plaster to the dorsal and volar surfaces of the arm from the fracture point or above down to

the wrist. The adhesive is doubled back on itself over the hand so that it will not adhere; 2½- or 3-inch adhesive is used and is covered with a gauze bandage to promote adherence. A short piece of light 3/16- or 1/8-inch braided cotton rope is tied to the end of each of the two adhesive straps.

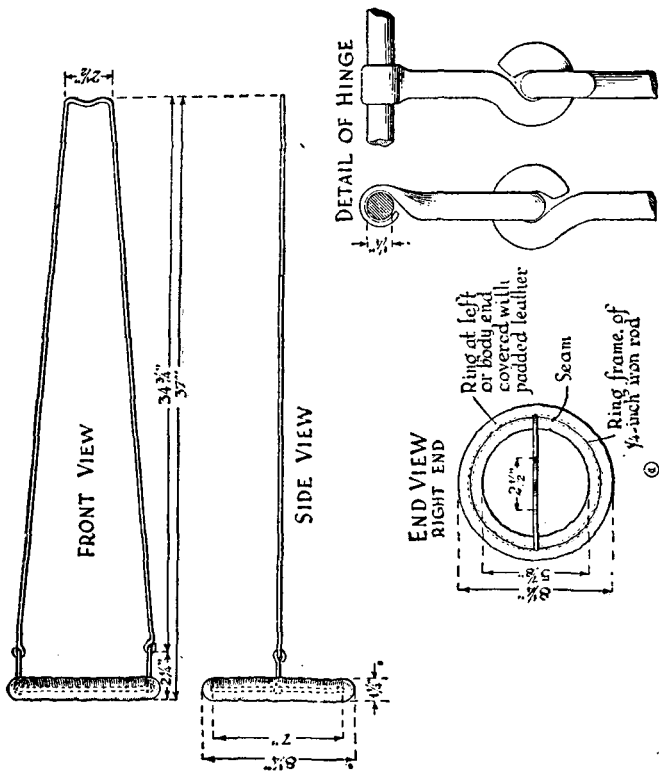

(3) While *A* still makes traction, *B* threads the arm through the ring of the hinged ring traction splint until it rests against the chest wall and shoulder girdle. He then ties the ropes from the adhesive traction straps to the end of the splint. A small piece of wood is passed between the adhesive straps at

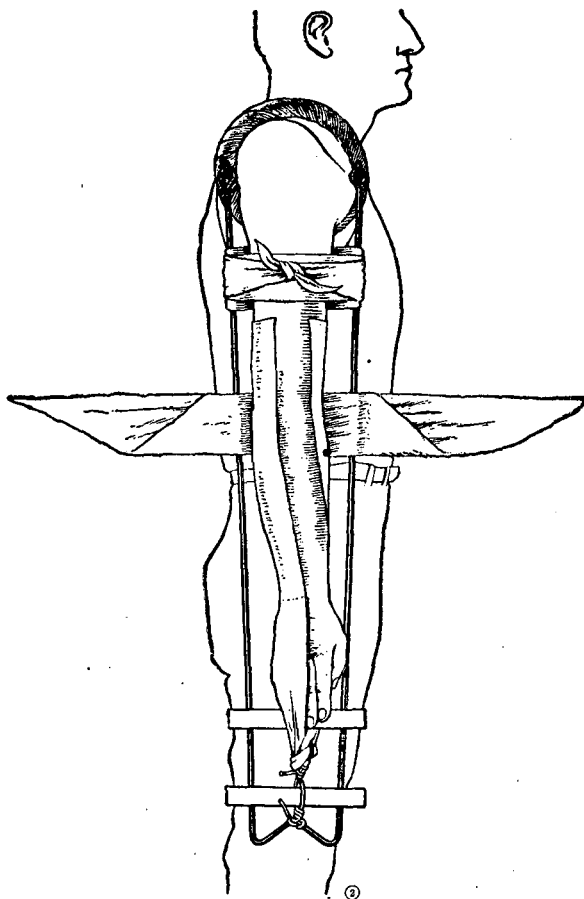

FIGURE 9.—Thomas splint, arm-hinged, for right or left arm.

the finger tips to prevent torsion of the adhesive on the hand; while *B* increases traction with a second piece of wood between the ropes by the Spanish windlass method.

(4) *A* and *B* secure the arm and forearm to side bars of splint, using three or more triangular bandages.

■ 10. **BASSWOOD SPLINT.**—*a. Material.*—These splints are made of Basswood, Yucca, or other equal material. Basswood is preferable, and should be at least $\frac{3}{16}$ inch thick. Size 4 by 18 inches by $\frac{3}{16}$ inch, in sets of 10. They are issued in this length for field use.

b. Uses.—Temporary splinting for transportation in case of injuries to—

- (1) Forearm.
- (2) Wrist.
- (3) Hand.

c. Application.—Gauze cotton pads or first-aid packets, large, are used as padding. The two board splints are held in position by three or more turns of gauze bandage tied rope fashion about them: (See fig. 10.)

■ 11. **PREVENTION AND EARLY TREATMENT OF TRAUMATIC SHOCK.**—*a.* Traumatic shock is a condition which results from a disproportion between the volume capacity of the vascular system and the circulating blood volume. The development of shock is hastened by pain, fear, hemorrhage, dehydration and starvation, loss of body heat, repeated injury such as soft tissue damage resulting from fractures inadequately splinted, administration of general anesthetic agents, and major operative procedures carried out before shock is controlled.

b. The initial treatment of shock should be preventive, and measures to prevent the onset of this condition should be initiated as soon after injury as possible. Once the full state of shock has appeared, the changes are irreparable. Under field conditions, it is essential that the patient in shock be transported to the battalion aid station or installation farther in the rear where treatment can be adequately administered and the patient should be transferred with a minimum of pain and discomfort. Pain is controlled by adequate doses of morphine sulphate. Barbiturates (sodium amytal or nembutal) in large doses should be administered by mouth in the battalion aid station for the purpose of delaying the onset of shock. Hemorrhage should be stopped. Simple fractures should be immobilized by splinting before the patient is moved. Compound fractures should be dressed, no attempt being made to reduce the fracture, and then

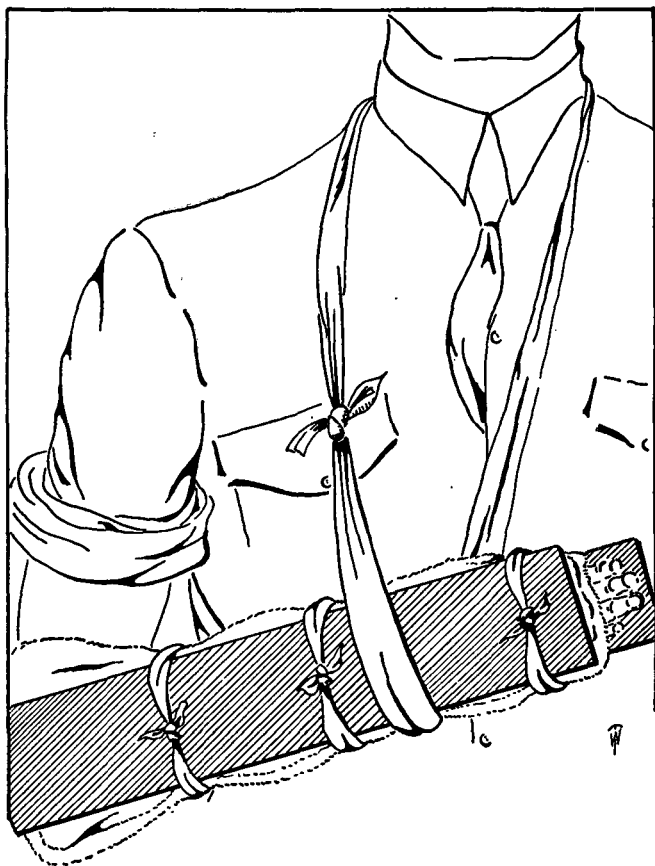

FIGURE 10.—Temporary splinting of forearm, wrist, and hand for transportation.

immobilized by splints, traction being absolutely essential to prevent soft tissue damage. Suspected fractures of the vertebrae should be placed on litters in hyperextension. Loss of body heat must be prevented by enclosing the patient with blankets and/or clothing. The patient is then ready to be transported in a recumbent position to a medical installation farther in the rear.

c. As the most important factor in preventing shock is the replacement of lost fluid, this should be done at the earliest possible moment. 300 to 500 cc. of 6 percent acacia can be given intravenously in the collecting station or clearing station, and is followed by whole blood or plasma when available. In the hospital station, the casualty is placed in a shock bed in the Trendelenburg position and heat is applied. Oxygen in high concentration should be administered by mask, and barbiturates should again be given by mouth. After these preliminary measures are carried out, the casualty should be in an operable condition. When indicated, however, further supportive treatment in the form of intravenous fluids should be given throughout the procedures.

SECTION III

SPLINTS AND APPLIANCES USED IN DEFINITIVE CARE OF BONE AND JOINT INJURIES

■ 12. GENERAL.—War wounds have always represented a major problem in military surgery. Among these, compound fractures play a major role. In the treatment of these conditions the same principles apply as in the traumatic surgery of civil practice, except that ideal conditions attending their care are frequently lacking in the traumatic surgery of war. The time element between receipt of injury and institution of definitive measures is of utmost importance in minimizing the morbidity and mortality which attend these injuries. Hospitalization and treatment is necessarily largely influenced by the type of combat, facilities for evacuation and availability of early definitive measures. In the treatment of compound fractures, regardless of what type or form of immobilization of the skeletal structures is instituted, the treatment of associated soft tissue injuries is of paramount importance.

The treatment of compound fractures has two objectives: To avoid or control infection, and to restore as accurately as possible alinement and contact of the fragments and so maintain them throughout the process of repair. Debridement or cleansing of the wound meets the first requirement. This means excision of all damaged tissues particularly those deprived of circulation, the removal of extraneous material and the thorough flushing of the wound with a nonirritating solution (normal saline). It should be emphasized that the use of strong antiseptics in the wound, either at the time of first aid treatment or during subsequent debridement, is not in accord with present practice and is to be avoided. Chemotherapy in the form of sulfanilamide instilled either directly in the wound or administered orally, or both, is being used experimentally in compound fractures and may prove to be an agent of value. The second, requirement, reduction and immobilization of the fracture, may be attained by the application of one of the various accepted methods.

■ 13. DEFINITIVE TREATMENT OF FRACTURES.—The comments given in this section are intended to be informative only and are not to be considered a detailed treatise on fracture therapy.

a. Closed reduction.—Under anesthesia (general, spinal, local, or intravenous) the fracture is reduced by manipulation after the muscle, relaxed by anesthesia, has been completely "paralyzed" by traction. The reduction is maintained by the use of splints or plaster of paris.

b. Suspension and traction.—The fractured extremity is suspended on a splint or appliance and reduction is accomplished by prolonged traction by means of the weight and pulley method. The proximal fragment being fixed by the muscles inserted into it, the distal fragment is pulled in its prolongation and so alined. Length, alinement, and contact are the goal. Overpull of the fragments must be avoided.

c. Open reduction.—The fracture site is opened and reduction accomplished under direct vision. To maintain reduction, some type of internal fixation is generally used, such as steel or vitallium plates and screws, nails, bands, etc., and this is ordinarily reinforced by some type of external fixation, as splints or plaster of paris.

■ 14. BALKAN FRAME (fig. 11).—*a. Material.*

Bag buckshot, 3-inch (holds 1 pound)	10
Bag buckshot, 5-inch (holds 5 pounds)	10
Bag buckshot, 8-inch (holds necessary number of 1- and 5-pound shot bags)	5
Buckshot, coarse	50
Clamp, large (detail C, fig. 11 ①)	10
Clamp, small (detail D, fig. 11 ①)	10
Hammock for suspension of pelvis, large	1
Hammock, small (fig. 11 ④)	1
Poles (detail A, fig. 11 ①)	1
4 feet by 1¾ by 1 inch	3
6 feet by 1¾ by 1 inch	5
8 feet by 1¾ by 1 inch	4
Pulley assemblage (detail B, fig. 11 ①)	8
Rope, 3/16-inch, braided cotton (unglazed)	30

b. Uses.—For suspension of upper extremity, lower extremity, fractures of the pelvis, or the whole body when in plaster.

c. Application.—(1) The middle overhead pole of the frame from which the leg is suspended is placed parallel with the long axis of the leg. Sufficient weight (1- and 5-pound shot bags) is placed in the open-mouthed bag to balance the weight of the splint and leg. The rope going over the pulley at the head of the bed carries sufficient weight (about 8 pounds) to hold the ring of the splint in position against the ischial tuberosity. Traction is obtained by means of weights (25 to 30 pounds) through adhesive skin traction, ropes, and pulley. (See fig. 11 ② and ③.)

(2) The extremity is suspended in the splint by the use of canton flannel (5-inch) bandages as slings, using large safetypins for fixation.

(3) Length is obtained by weight and pulley traction. Alinement is obtained by abduction, adduction, flexion, or extension of the distal end of the distal fragment. Alinement is also changed by adjusting the position and tightness of the supporting canton flannel slings.

(4) Figure 11 ② and ③ shows an intertrochanteric fracture of the femur treated in extreme abduction, using skin traction.

(5) The frame allows any position of abduction or adduction. All four extremities or any combination may be suspended at one time.

(6) The foot of the bed is ordinarily elevated so that the body will better act as a counterweight against traction.

(7) If there is a wound in the region of the ischial tuberosity, the half ring of the splint may be reversed to the anterior surface of the thigh and dressings held in place behind by the strap and buckle.

(8) A "monkey bar" made of a broomstick and suspended from the frame by rope so that it hangs within reach of the patient is a welcome aid to him in changing his position in bed.

d. Fracture of humerus treated by skin traction in abduction (fig. 11 ④).—(1) The humerus is suspended in a canvas hammock 8 by 30 inches, with ends of canvas-covered wood in which four eyelets are placed. Laces are passed through these eyelets as shown in figure 11 ④.

(2) The forearm and hand are suspended from a wooden spreader, made locally, using four 1-inch steel buckles and sufficient 1-inch nonelastic webbing.

(3) A piece of broomstick makes an excellent handhold.

(4) Position of the distal fragment is changed by abducting or adducting the arm and likewise by changing the supporting pole of the suspending frame and by increasing or decreasing the weight attached to the forearm or that attached to the hammock.

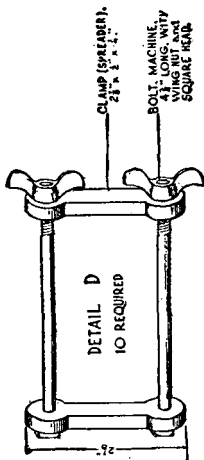
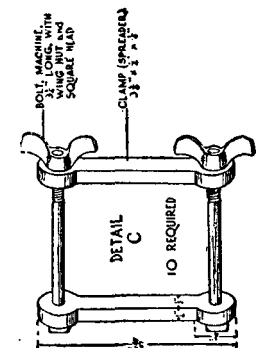

DETAIL A.
SHOWING METHOD
OF ASSEMBLING TIMBER
AND FIXTURES.

TIMBER REQUIRED:
3 LENGTHS 4" x 1 1/2" x 1'
2 LENGTHS 6" x 1 1/2" x 1'
4 LENGTHS 8" x 1 1/2" x 1'
USE WHITE PINE OR FREE
GROW TIMBER AND THE
EFFECTS OF WEATHER

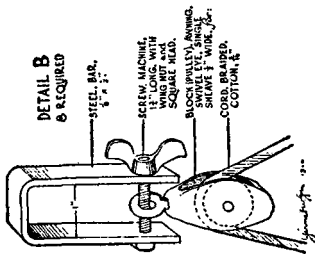
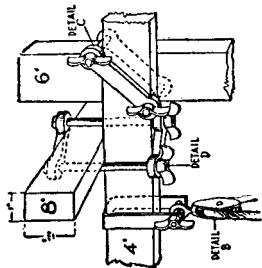

① Metal parts and timber.

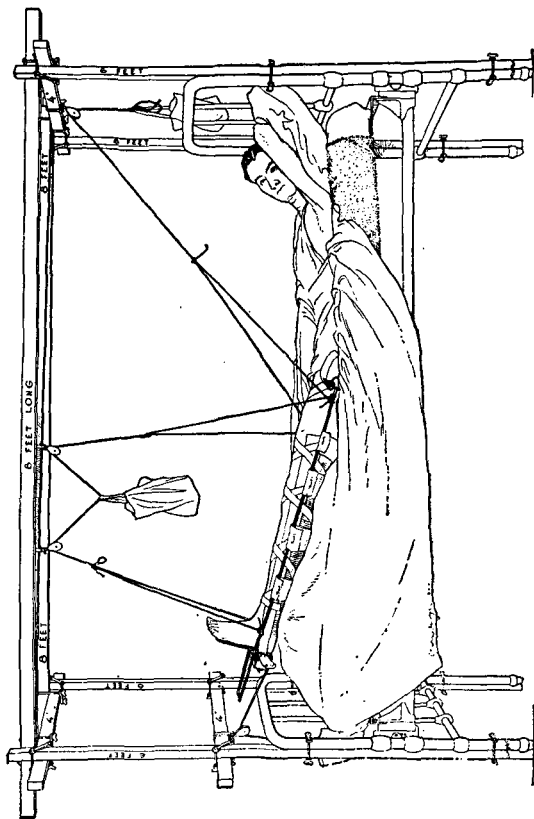

② Side view.

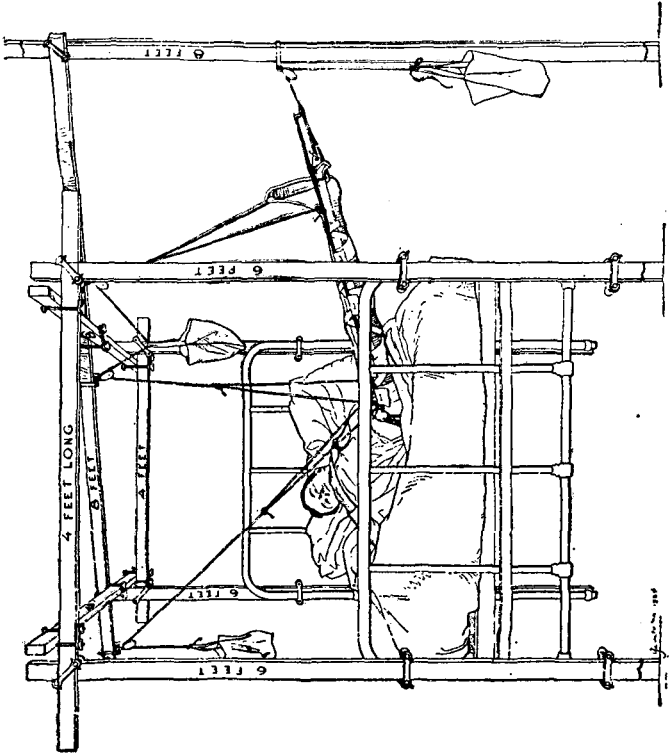

④ Thigh in abduction.

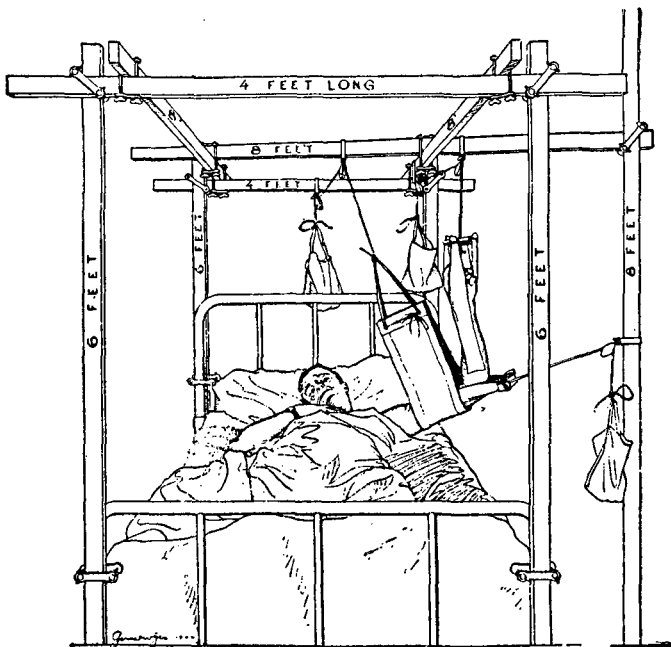

⊙ Fracture of upper extremity.

FIGURE 11.—Balkan frame.

■ 15. SKIN TRACTION (fig. 12).—*a.* The skin is prepared by shaving, cleansing with gasoline and alcohol, and drying.

b. A strip of adhesive is rolled from a 3-inch spool and doubled on itself sufficiently so that this double thickness will extend from above the malleolus to the buckle of the spreader. The strip is then cut the length desired. A second strip is likewise prepared. A third strip is split in half to be used as the spiral. The lateral and mesial straps extend upward to the fracture site and are applied and bound by the spiral straps. It is applied evenly, wrinkling being avoided as it produces blisters.

c. The spiral should avoid the peroneal nerve over the neck of the fibula, the supra patella bursa, and should not be

bandaged tightly about the ankle. The leg is then bandaged with a gauze bandage to promote adhesion.

d. An alternate method employing a liquid adherent or glue is more efficient. An excellent commercial product for this purpose is available (ace adherent). It is more comfortable and more lasting than adhesive tape and more easily applied. The glue is applied freely to the unshaved skin and is allowed to dry 1 to 2 minutes. Two strips of flannel bandage cut to proper length are then applied with furred side to the skin.

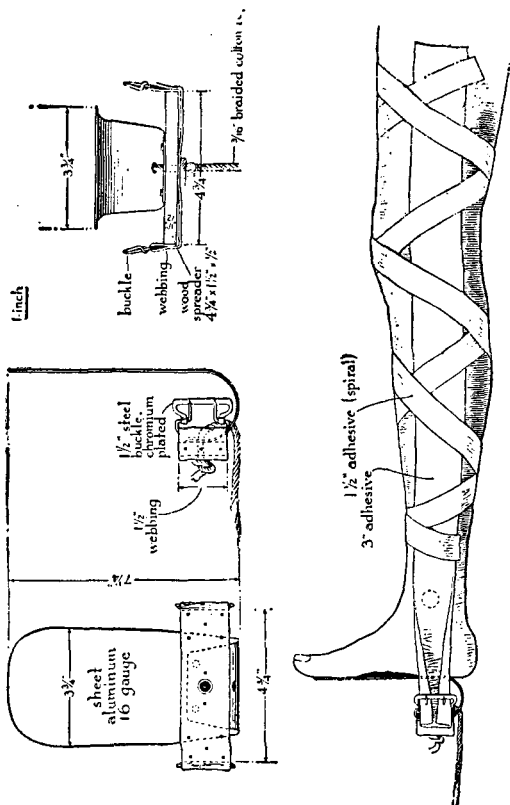

FIGURE 12.—Skin traction using zinc oxide adhesive and spreader.

The extremity is snugly wrapped with biased muslin bandage. Traction may be applied immediately.

e. For below-knee traction, the adhesive extends only to the knee. The spreader and foot support are made locally from sheet aluminum; webbing 1½ inch, gray, nonelastic; buckle 1½ inch, two-prong; wood 4¾ by 1½ by ½ inch pine; tacks, rivets, or screws.

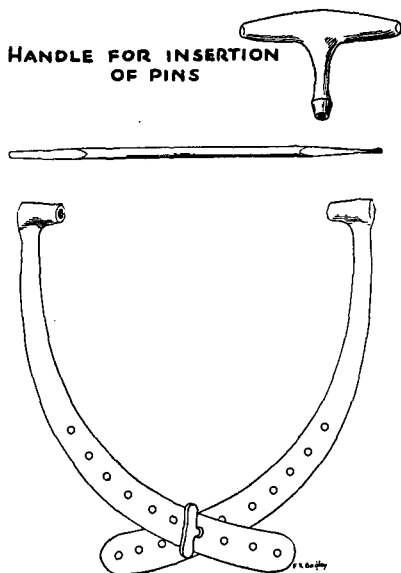

FIGURE 13.—Steinmann extension apparatus.

■ 16. STEINMANN EXTENSION APPARATUS (fig. 13).—*a.* This apparatus consists of a handle for insertion of pins; three stainless steel pins, 4½, 6, and 7 inches; and a pinholder.

b. All pins are solid. Pins are expendable and can be requisitioned separately as to size and number desired.

■ 17. SKELETAL SUSPENSION AND TRACTION (fig. 14).—This type of traction is much more effectual than skin traction and generally preferable where facilities are available.

a. In fractures of the shaft of the femur and in supra-condylar fractures, Steinmann pin or Kirschner wire is placed above the condyles in the mid long axis of the femur or a Steinmann pin or Kirschner wire through the metaphysis of the tibia.

b. In all fractures of shafts of both bones of the leg, except simple, transverse fractures without displacement and in simple fractures of the shaft of the tibia with shortening and deformity and in compound fractures of this bone, skeletal traction using the Steinmann pin or Kirschner wire through the distal end of tibia or os calcis, is applicable.

c. Skeletal traction is indicated in fractures of the humerus when compound, or when skin traction is not effectual; oblique fractures at the upper one-third; T-fractures into the elbow joint. This is best attained through the medium of a loop of stainless steel wire placed through a drill hole through the proximal third of the ulna, or by means of a Kirschner wire similarly placed and held taut by a tractor.

d. This method has the following disadvantages: It does not permit positive control of the proximal fragment—it requires prolonged bed rest in the recumbent position. It is, however, the most effective method of treatment where more positive methods of control of both fragments are not available.

■ 18. WIRE APPARATUS.—Various types of apparatus are available on the market for the introduction of fine wire through soft tissue and bone for obtaining traction, one of which is the Kirschner wire apparatus shown in figure 15. Different types of “tractors” for making tension on the wire in its long axis and allowing traction to be made, are also obtainable.

■ 19. SKELETAL FIXATION OF PROXIMAL AND DISTAL FRAGMENTS (figs. 16 and 17).—More effectual than the method given in paragraph 16 is one which employs direct skeletal control of both fragments through the medium of either wire, pins, or dual pins in each. This method requires the use of a reducing frame in which the transfixion elements are placed following introduction, whereupon by mechanical adjustments the fracture is reduced and aligned and so maintained by the application of plaster which incorporates the transfixion pins or

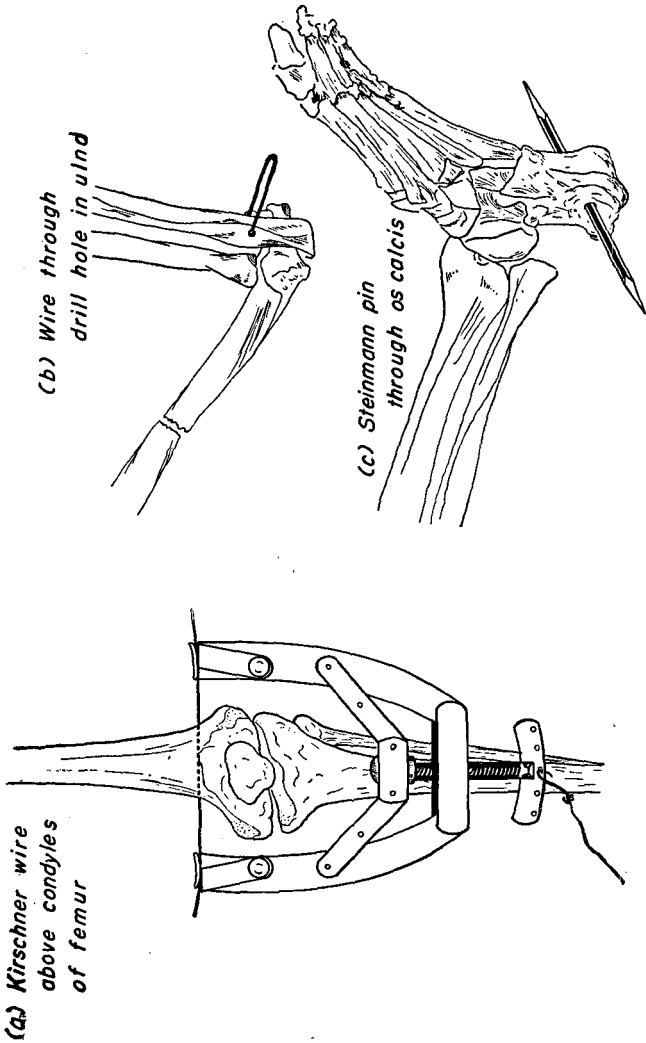

FIGURE 14.—Application of skeletal traction.

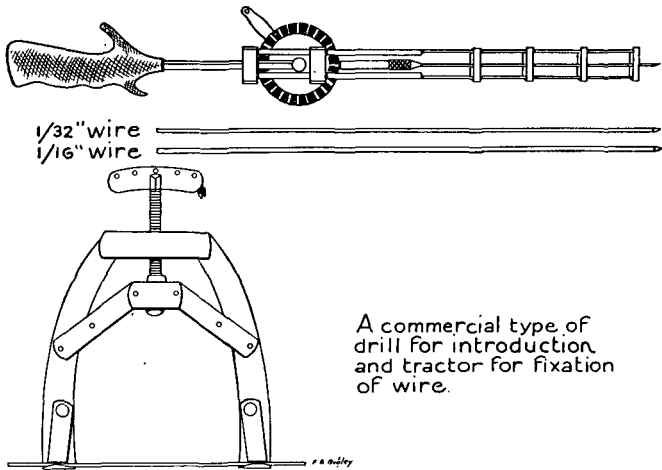

FIGURE 15.—Kirschner wire apparatus.

wire. To apply this method successfully to fractures of the femur or humerus, more positive control than can be obtained by the use of a single pin or wire is necessary, and to this end dual pins are employed in such a manner that direct control of each fragment may be had in any or all of three dimensions. This method has much to commend it. Its advantages lie in its ability to effect an immediate reduction and alinement of the fracture, lack of necessity for fixation of contiguous joints, and early ambulatory treatment. It eliminates the factor of uncertainty and prolonged bed rest where reliance is placed on the control of the distal fragment alone. By permitting ambulatory treatment, its application to fractures of the lower extremities under combat conditions is obvious, whereby large numbers of beds which would otherwise be immobilized for prolonged periods of treatment can be diverted to other uses. Various commercial types of apparatus are available for the employment of this method. Typical examples are given in figures 16 and 17.

■ 20. ATTACHMENT PIERSON (fig. 18).—*a. Construction.*—Cold rolled or Bessemer steel rod, $\frac{3}{8}$ inch. U-shaped in construc-

tion, 24 to 25 inches long, $6\frac{1}{2}$ inches wide at the open end, $4\frac{1}{2}$ inches at the other. To each open end is attached a metal hinge, freely movable on the Pierson attachment, which will lock the attachment to a fixed place on the Army hinged half-ring splint.

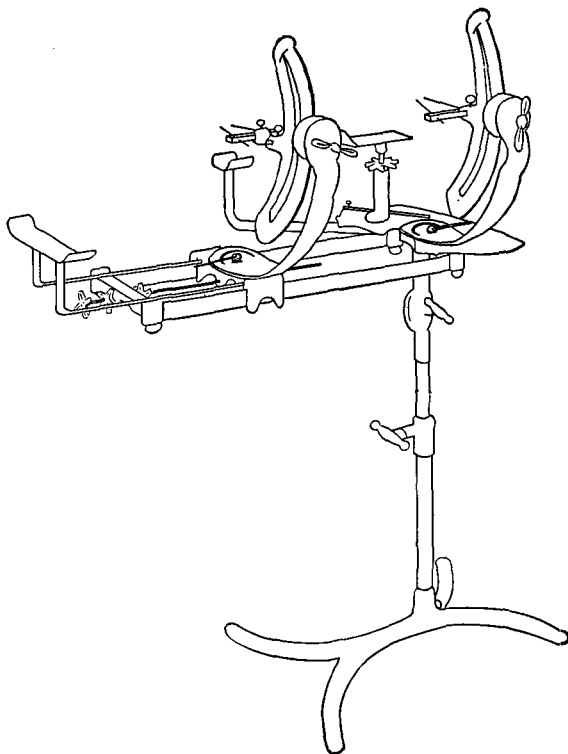
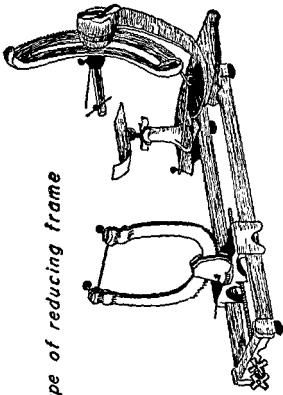
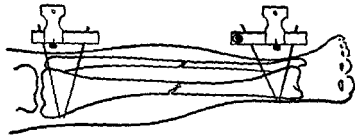

FIGURE 16.—Frame for reduction of fractures by skeletal traction and countertraction.

b. Uses.—In supra condylar fractures where knee flexion is necessary for reduction of the fracture in conjunction with skeletal traction, in suspension traction treatment of all thigh



A type of reducing frame



Dual half pins in tibia

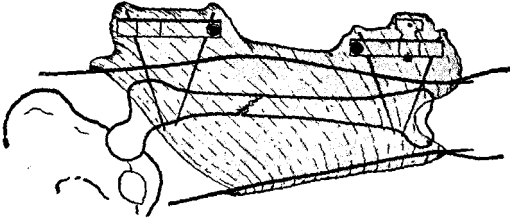

*Dual half pins
in femur and
completed cast*

FIGURE 17.—Skeletal reduction and fixation of fractures.

and leg fractures to allow early knee motion, and in other conditions when traction and knee motion are desired.

■ 21. CABOT SPLINT (fig. 19).—*a. Construction.*—Cold rolled or Bessemer steel rod, $\frac{1}{4}$ inch.

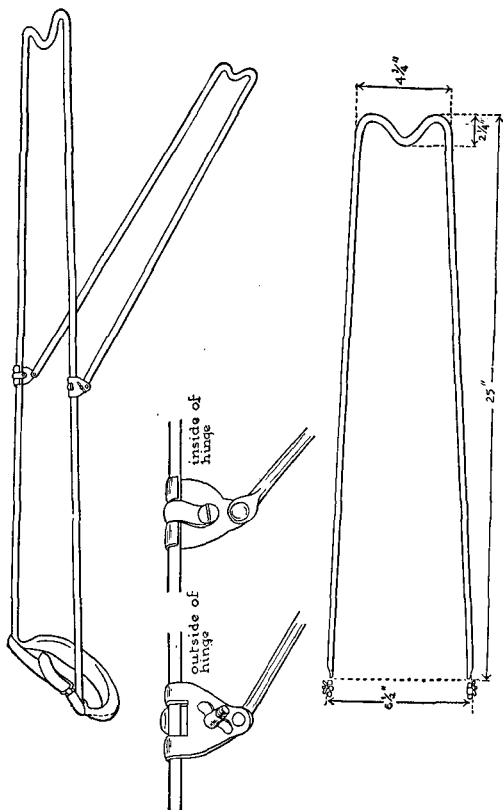

FIGURE 18.—Pierson attachment for Army hinged half-ring leg splint.

A figure is constructed using this steel rod, approximating but not exactly that of a parallelogram with the free ends welded. One end of the weld will measure $7\frac{1}{4}$ inches, the other end, $4\frac{1}{4}$ inches. The small end of the frame is bent at a right angle to the plane of the frame 12 inches back from

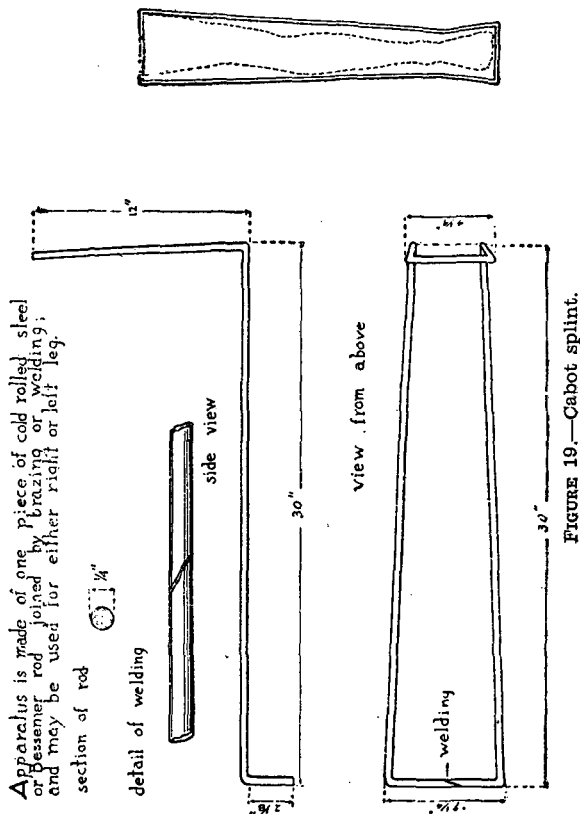

FIGURE 19.—Cabot splint.

this end. The two sides measure 30 inches. The large end which has been braized or welded, will present a $2\frac{1}{8}$ -inch concavity at its center.

b. Uses.—For immobilization of knee, ankle, foot, and soft parts of the leg.

c. Application.—A hammock is formed on which the extremity is supported in the steel frame by wrapping about it, not too tightly, with a bias muslin bandage. Additional padding may be added, using gauze and cotton pads as desired.

The extremity should at no place rest on the metal bars of the splint. The splint may be bent at the knee to give any amount of flexion desired. The extremity is bound to the splint, using additional muslin bandages.

■ 22. ALUMINUM COCK-UP WRIST SPLINT (fig. 20).—*a. Material and construction.*—(1) Sheet aluminum, half hard 0.051 inch; aluminum bar, half round, $\frac{5}{8}$ by $\frac{3}{8}$ inch.

(2) The splint is made of 1 piece of sheet aluminum, half hard, 0.051 inch thick, measuring $7\frac{3}{4}$ inches in length with a width of $3\frac{1}{2}$ inches at its proximal end, narrowing down to $2\frac{3}{4}$ inches at its distal end, with rounded ends and smoothed edges. 1 piece of sheet aluminum, half hard, 0.051 inch thick, triangular in shape, measuring 2 inches in length and $1\frac{3}{4}$ inches in width at its greatest diameter, tapering to $\frac{3}{4}$ inch. All corners are rounded and edges smoothed off. 1 piece of aluminum bar (trim), half round, measuring 7 inches in length, $\frac{5}{8}$ inch in width, and $\frac{3}{8}$ inch in thickness.

(3) The sheet aluminum members are securely attached to the flat surface of the aluminum bar. The smaller sheet is attached by one rivet and the larger by two rivets, each passing through the center of the sheet aluminum members at right angles to their long axis. The sheet aluminum members are well rounded with the concave portions away from the supporting aluminum bar. The small aluminum plate, which rests in the palm of the hand, is slightly movable in order that it may be adjusted for use in either hand. The aluminum bar forms a gradual angle of approximately 58° from the horizontal plane of the splint. The gradual angle described conforms to an arc of a radius of $1\frac{3}{8}$ inches. The beginning deviation from the horizontal plane is 9 inches from the proximal end of the splint. The overall length of the assembled splint is $10\frac{3}{4}$ inches when measured from tip to tip in a straight line.

b. Uses.—For fixation of the wrist joint in dorsal extension:

- (1) Arthritic condition in wrist.
- (2) Paralysis or weakness of extensor muscle.
- (3) As a post operative splint.

c. Application.—(1) Properly applied, the splint allows free motion in the metacarpal-phalangeal joints and in the thumb,

that is, no pressure on the thenar eminence to produce "flat hand."

(2) The bar part of the splint is sufficiently flexible so that the splint may be properly fitted to the hand and the desired amount of cock-up may be obtained.

(3) Care should be exercised in adjustment so that strain will not be thrown on rivet connecting bar with flat splint piece and thereby breaking the splint.

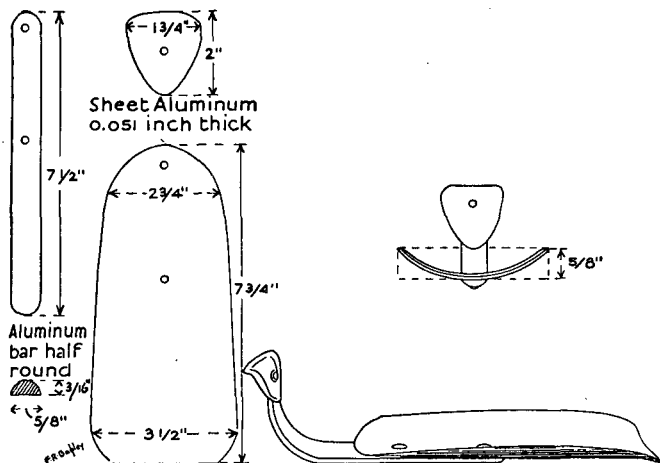

FIGURE 20.—Aluminum cock-up wrist splint.

■ 23. T-SPLINT FOR FRACTURED CLAVICLE (fig. 21).—(Non-standard item, made locally.)

a. Material.

Wood, maple or hickory, 3 by 18 inches, two pieces.

Buckles for 1½-inch webbing, six.

Felt, saddle, gray.

Stockinette, 3-inch.

Webbing, 1½-inch.

Carpet tacks.

Rivets or screws.

(4) These dimensions are used for the average patient. Larger, 20-inch, and smaller, 16-inch, splints should be made up and available.

(5) For infants and young children, T-splints are made from basswood splint board, tacked together, padded, and fixed to the child with bandages and adhesive.

c. Application.—(1) In fractures of the clavicle, the shoulder drops downward, forward, and inward. The proximal fragment is usually pulled slightly anterior and upward.

(2) Traction is made upward, outward, and backward on the shoulder to reduce the fracture. The splint is applied to maintain immobilization.

(3) The inner strap on each side is brought up under the splint and over the shoulder at the base of the neck of the patient, crossed over the chest, and secured to the two upper buckles on the lower end of the vertical arm of the splint. The abdominal strap is applied. Both shoulders are now pulled upward, backward, and outward by the axillary strap and fixed in this position. Straps are adjusted daily and skin under splint cared for.

■ 24. AEROPLANE OR ABDUCTION SPLINT (fig. 22).—(Non-standard item, made locally.)

a. Material.

Buckles, 1½ inch, two-prong, three.

Rod, ¼-inch steel, Bessemer or cold rolled, 12-foot lengths.

Sheet, aluminum, 16-gage.

Webbing, 1½-inch, gray, nonelastic.

b. Measurements.—(1) Width of lower end of splint, average 7 inches, convex curve.

(2) Distance from just below anterior superior spine of ilium to anterior axillary fold.

(3) Length of arm, measured from anterior axillary fold to flexed elbow, arm in abduction.

(4) Length of forearm, measured from flexed elbow to middle of palm of hand.

(5) Line across palm, average 3 inches.

c. Construction.—(1) The ¼-inch steel rod is bent cold (easily accomplished by use of vise and hammer). The rod is joined and fixed under hand piece by fixing ends of rod in an aluminum cylinder. Aluminum cylinder formed from

a piece of aluminum $\frac{7}{8}$ by $2\frac{1}{2}$ inches, which is fashioned around a $\frac{1}{4}$ -inch steel rod using a vise and hammer.

(2) Three nonelastic webbing straps and buckles are attached to splint by sewing as illustrated.

(3) Canvas is sewed over the metal bars of the splint forming a hammock which supports the splint against the pelvis and chest wall and the arm and forearm on the splint. Gauze cotton pads are added as indicated. A bias muslin bandage may be used in lieu of canvas. The arm and forearm may be secured to the splint by a bias muslin bandage.

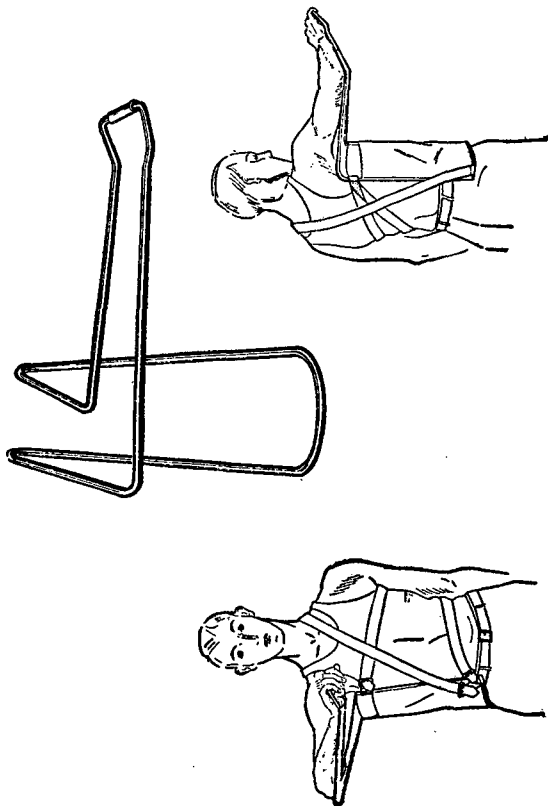

FIGURE 22.—Aeroplane splint.

d. Uses.—(1) Brachial plexus injuries.

(2) Paralysis or weakness of abductor muscles of shoulder.

(3) Shoulder joint injuries (other than dislocations).

(4) Fractures of the scapula. Surgical and anatomical neck of the humerus. Convalescent fractures of the shaft of the humerus.

(5) Subacromial bursitis.

(6) Acromial, clavicular dislocations.

■ 25. **BASSWOOD SPLINT.**—4 inches by $\frac{3}{8}$ inch, 5- to 10-foot lengths.

a. Uses.—(1) Splinting of forearm and carpal fractures.

(2) Coaptation splints.

b. Cutting of splints.—(1) The good forearm and hand, with hand in ulnar deviation when splint is being prepared in Colles fracture, is placed palm down on a piece of splint board and outlined with pencil as shown in figure 23. The broken line is marked in after hand is removed from board.

(2) The splint extends from just below the flexed elbow to the metatarso-phalangeal joints, so as to allow free motion in these joints and is cut away over the thenar eminence so as not to produce "flat hand."

(3) The posterior splint is marked out in a similar manner.

(4) The splints are now cut out from the splint board, using a plaster knife, pocket knife, or scroll saw.

c. Padding of splints.—Sufficient layers of sheet wadding which makes the best type of padding are laid on each splint and cut with a pair of bandage scissors to fit the splint. The padding is then secured to the splints with three or more narrow strips of adhesive.

d. Splinting of lower forearm fractures (fig. 23).—(1) *Colles fracture.*—The fracture is reduced, using general or local anesthesia. Two additional pads are formed of sheet wadding. The longer one is placed against the proximal fragment and the palmar splint is placed in position. The smaller pad is placed over the distal fragment and the dorsal splint applied. While the splints are held in position, the first adhesive strap, 1 to $1\frac{1}{2}$ inches wide, is placed around the wrist, to be followed by a second one around the upper end of the splint, and a third around the lower end securing the hand in ulnar deviation. A gauze bandage is now applied.

Splints should show a "spring" when compressed by the operator's hands to insure that they do not bind too tightly.

(2) *Other forearm fractures.*—Splints are applied as in Colles fracture, except—

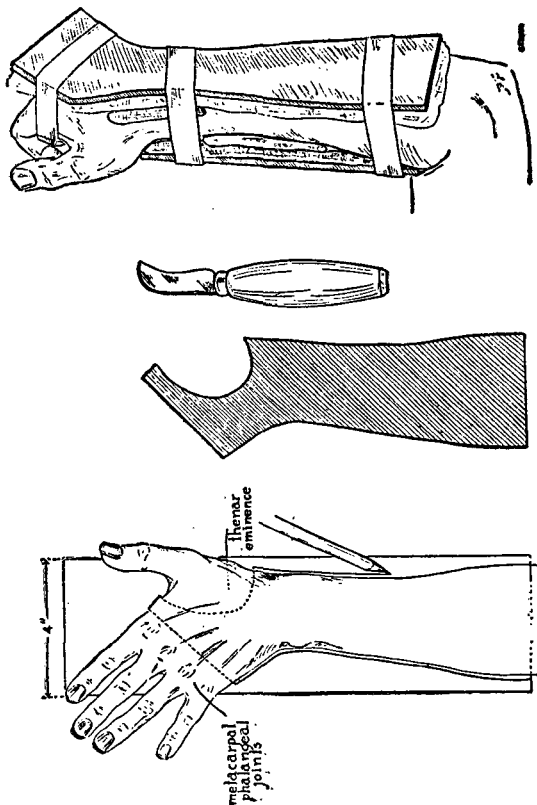

FIGURE 23.—Splinting of lower forearm fractures.

(a) Ulnar deviation may or may not be desired.

(b) Position and size of the supplemental pads are changed as indicated to maintain reduction of fragments.

■ 26. PLASTER OF PARIS (4-lb. tins).—*a. Specifications.*—Orthopedic plaster will have a compression strength of not less than 2,400 pounds per square inch. It shall set in not less than 6 minutes nor more than 15 minutes. The label should indicate the water plaster ratio for obtaining the testing consistency. Good results depend upon the proper proportion of water.

b. Bandages (5 inches by 5 yards).—One dozen sealed in metal container, each bandage individually wrapped in wax paper or equivalent field item.

(1) *Material.*—Six yards of crinoline, 1 yard wide, to contain 32 by 28 threads per square inch. Only starch sizing to be used and not to excess. Torn in strips, six to the bolt, each 6 yards long, the selvaged edge is removed and all loose threads from the frayed edges. Each strip is rolled in bandage form.

(2) *To make bandages.*—Plaster of paris is placed on a table before which is seated the operator who works the plaster into the prepared 5-inch by 6-yard strip of crinoline. With the right hand, plaster of paris is placed on the crinoline and worked into its meshes, the excess being removed by a spatula, while with the left hand, the crinoline with its contained plaster is rolled into a bandage. An inverted bowl may be used to work the plaster into the bandage and remove excess. If the bandage is rolled too tightly, it will not take up sufficient water to become properly wet through; if rolled too loosely, it cannot be handled; if too much plaster is incorporated, it will become "lumpy"; when insufficient is used, the cast from which it is made will be weak and unsatisfactory. The average weight of a satisfactory plaster of paris bandage of this size is 8 ounces.

c. Care.—(1) Plaster of paris is prepared by heating gypsum until three-fourths of the water of crystallization is driven off under definite heat control and is then ground to a fine powder. If not properly heated or ground, poor plaster of paris is the result. It tends to take up moisture from the atmosphere and "set," that is, return to gypsum, so that it must be kept dry at all times. The plaster falls from the meshes of the crinoline if handled roughly.

(2) A pail type commode is an excellent container in which to seal plaster bandages.

(3) Plaster of paris not in bandage form is kept in the original 4-pound tin until used.

■ 27. PLASTER CASTS.—*a. Material.*

Plaster bandages.

Stockinette, 3-inch, 6-inch, and 9-inch.

Wadding, sheet (5-inch by 5-yard rolls).

Knife, plaster.

Shears, plaster of paris, Stille.

Felt, soft, gray, 1/2-inch.

b. Application.—Casts may be applied to the extremities without padding by molding directly against the unshaven skin. When padding is used, sheet wadding is necessary. It is nonabsorbing and ideal. Stockinette is always used next to the skin in body casts and hip spicas. It may or may not be used, as desired, on the extremities. Felt is used as additional padding in body casts and hip spicas, covered by cotton wadding. Absorbent or nonabsorbent cotton should not be used under plaster, as it takes up and retains moisture, preventing the proper setting of the plaster.

c. Handling of plaster bandages.—(1) The water in which bandages are placed should be warm. Cold water delays setting of plaster; hot water hastens setting. The bandages should be set on end in a bucket of water and completely submerged. They should not be handled or removed until all bubbles cease to appear. If allowed to soak too long the plaster will "set" in the water. The excess water is expelled by grasping each end of the bandage and squeezing toward the center.

(2) Plaster bandages may be applied circularly about the body or extremity, rubbing the plaster in with each turn forming a cast or casing. The points of greatest stress where breaking is feared may be reinforced by plaster slabs. These slabs are made by running plaster bandage back and forth on itself on a flat board for the desired length and thickness and rubbing the layers well with the hand. Reinforcement of casts with metal or wood is not necessary and should be avoided.

(3) Molded plaster splints are made in the same manner; slabs are cut to the desired size, molded to the part to be splinted, and fixed in this position until set.

(4) Plaster splints are often indicated in Colles fractures, and plaster is usually applied in this form when a nonpadded cast is desired.

■ 28. PIPE FRAME AND HAMMOCK FOR HYPEREXTENSION BODY CAST (fig. 24 ①).—(Nonstandard item, made locally.)

a. Construction.—Pipe frame and windlass are made of $\frac{3}{4}$ -inch wrought iron pipe, elbows, and T-joints and can be made by any plumber or pipe fitter. Canvas for hammock is type used on the standard litter. One-inch nonelastic webbing is sewed to the canvas so as to fix it to the shaft or windlass of the frame.

b. Uses.—(1) For suspension of patient for application of body cast or plaster shells in lesions of spine below dorsal vertebrae particularly when hyperextension is desired.

(2) Compression fractures.

(3) Tuberculous spondylitis.

(4) Fractures of lamina and transverse processes.

(5) In lesions at or above the 6th dorsal vertebrae, the head must be incorporated in plaster so that overhead jury mask traction is used for suspension while the cast is applied.

c. Application (fig. 24 ②).—(1). The two ends of the pipe frame are placed on tables. A piece of 9-inch stockinette, cut of proper length, and with slits for armholes is rolled on itself and placed over the canvas hammock.

(2) The lower end of the canvas is fixed to the leather straps by inserting a piece of $\frac{3}{8}$ -inch pipe. The webbing straps are threaded through the four slots in the shaft, the shaft turned by the handle, fixing the straps on themselves by friction and the canvas made taut. The shaft is fixed by the iron pin.

(3) The patient is laid face down with head between straps and the shaft and stockinette brought down over the patient's body.

(4) The desired amount of hyperextension is obtained by loosening or tightening the shaft; the body is properly padded and the cast or shell applied.

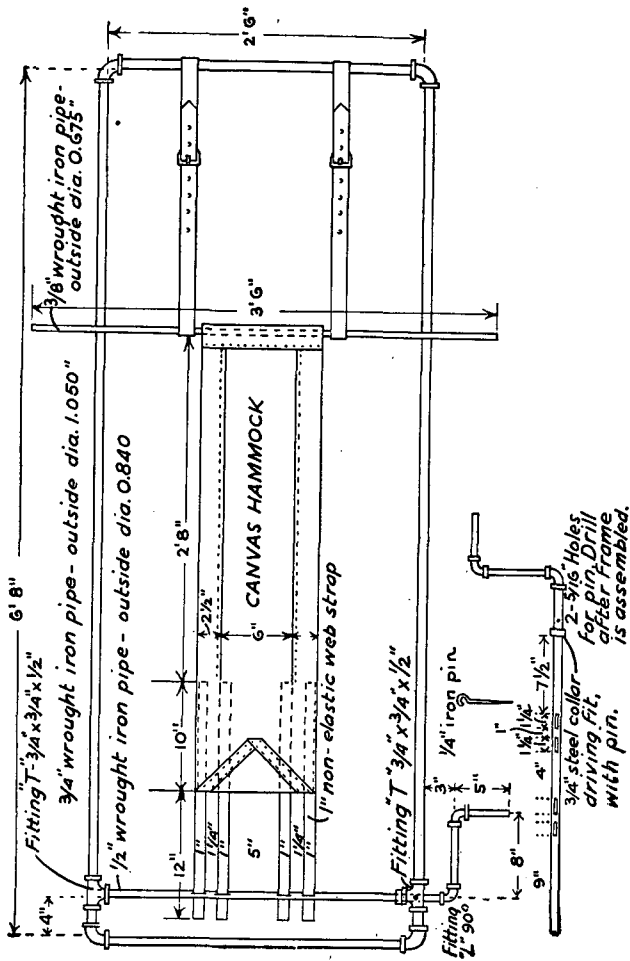

① Construction.

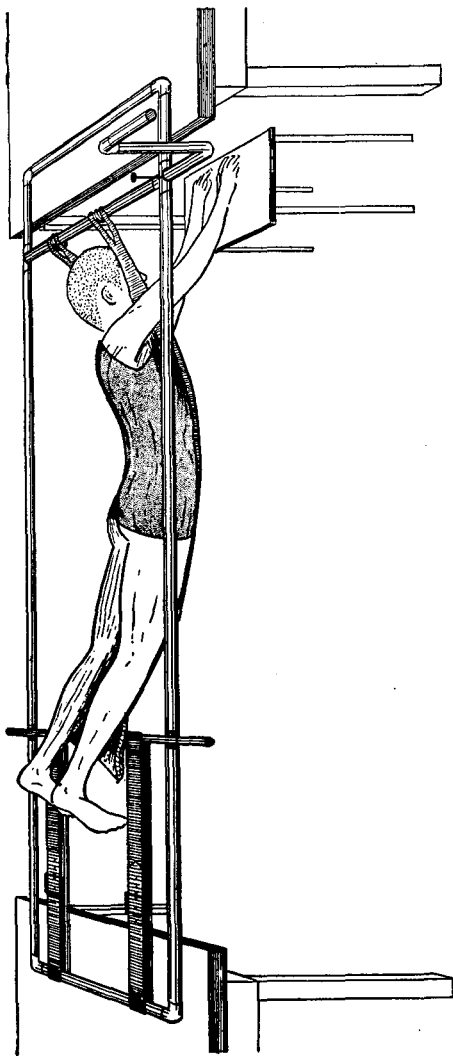

② Application.

FIGURE 24.—Pipe frame and hammock for hyperextension body cast.

(5) When the cast has dried sufficiently, the rod connecting the leather straps and canvas and the webbing straps from the shaft are removed while the patient is supported by attendants. He is then placed on his back on a wheel litter or bed and the canvas removed.

■ 29. COMPRESSION FRACTURES OF SPINE (figs. 25 and 26).—
a. In definitive treatment of compression fractures of the lumbar and lower thoracic spine where definite contra-indications do not exist, full hyperextension can be attained by postural reduction. The patient is suspended face downward between two tables with manubrium and arms resting on the table and thighs on another table. Cast is applied without other support. Full postural reduction is thus secured. With the patient in this position a plaster cast is applied.

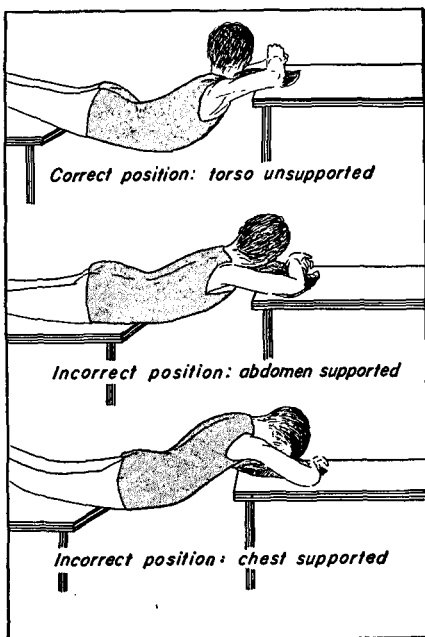
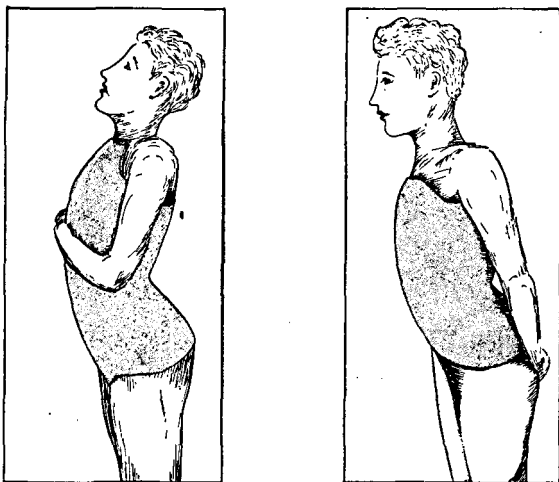

FIGURE 25.—Postural reduction of compression fracture of spine.

b. Maintenance of hyperextension requires contact at three points; posteriorly at the site of injury, high against the manubrium, and low against the pubis.

c. A large abdominal window may be cut after the cast dries and patient may be ambulatory after pain and distention subsides. Experience demonstrates the necessity for prolonged immobilization for a period averaging 6 months.



Correct: Cast high on chest, low on pubis; and supporting lumbar spine. Incorrect: Cast too short in front; does not maintain extension.

FIGURE 26.—Completed cast for ambulatory treatment of fracture of spine.

■ 30. FRACTURE OR DISLOCATION OF CERVICAL SPINE (figs. 27 and 28).—*a. General.*—This type of fracture requires continuous prolonged traction and hyperextension and subsequent immobilization in a brace or cast. The initial requirement of traction may be attained by means of a head halter or by direct skeletal traction to the skull. The latter method is more comfortable and more positive and is recommended as a procedure of choice. It is effected by means of metal tongs, a commercial pattern of which is illustrated in figure 28.

b. Application.—(1) For correct placement of the skull tongs, lines are painted on the scalp to indicate the midline of the skull and the approximate plane of the cervical articulations (above mastoid tips). With the traction bar resting on the midline, the points of the tongs are brought down upon the transverse line. These points of contact are marked for the placement of stab wounds.

(2) After injection of novocain (1 percent), stab wounds just large enough to admit the drill guard are made down to the skull.

(3) The drill point is forced to a depth of three millimeters in children and four millimeters in adults. The fixed guard prevents excessive penetration.

(4) The points of the tongs are fitted into the bone perforations and held in position until the tongs have been locked.

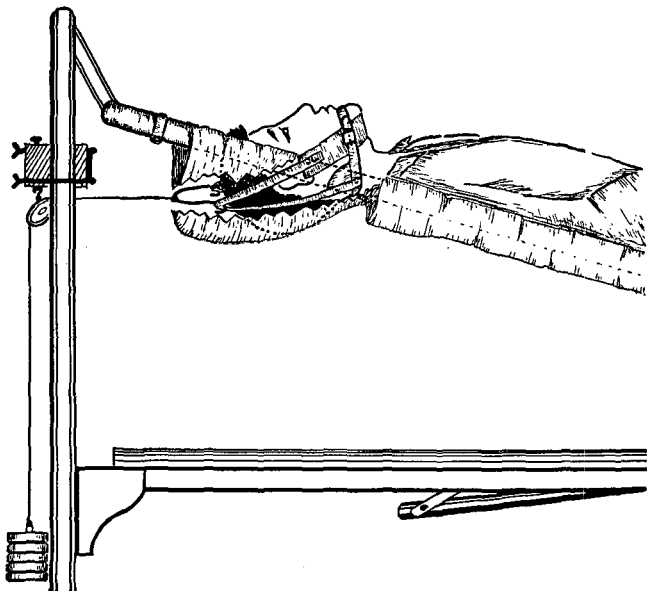

FIGURE 27.—Application of traction and hyperextension for fractures and dislocations of cervical spine.

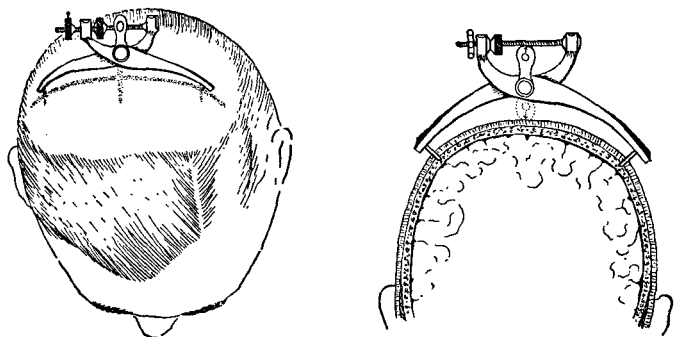

FIGURE 28.—Application of skull tongs for skeletal traction.

SECTION IV

BANDAGES AND DRESSINGS

■ 31. GENERAL.—The illustrations and most of the text in this section are taken from the Handbook of the Hospital Corps, U. S. Navy, and the courtesy of the Bureau of Medicine and Surgery in permitting the use of that handbook is acknowledged.

a. Bandages are employed to hold dressings applied to the surface of the body, to secure splints in the treatment of fractures and dislocations, to create pressure, to immobilize joints, and to correct deformity.

b. Various materials are employed in making bandages, such as gauze, flannel, crinoline, muslin, linen, rubber, and elastic webbing. Gauze frequently is used because it is light, soft, thin, porous, readily adjusted, and easily applied. Flannel, being soft and elastic, may be applied smoothly and evenly, and as it absorbs moisture and maintains body heat, is very useful for certain conditions. Crinoline, rather than gauze, is used in making plaster of paris bandages, as the mesh of the crinoline holds the plaster more satisfactorily than gauze. Muslin is employed in making bandages because it is inexpensive and readily obtainable. It should be soaked in water to cause shrinkage, dried, and finally ironed to remove wrinkles. A large piece of this material easily may be

torn into strips of the desired width. Rubber and elastic webbing are used to afford firm support to a part. The webbing is preferable to the pure rubber bandage, as it permits the evaporation of moisture.

c. It is of the greatest importance that an enlisted man, Medical Department, should become familiar with the general rules of bandaging and proficient in the application of various types of bandages. The comfort of a patient, security of the dressing, and professional reputation of the Medical Department depend upon proper application of a bandage. A neatly and properly applied bandage is an indication that the dressing covered by the bandage has been properly performed. An untidy, uncomfortable, insecure, improperly applied bandage reasonably may lead one to suspect that the underlying dressing is of the same character and can result only in adverse criticism.

d. Various types of bandages, commonly used, are the roller bandage, the triangular bandage, and the many-tailed bandage. The roller bandage is made from one of the materials mentioned in *b* above, the width and length depending upon the part to be bandaged. For convenience and ease of application, the strip of material is rolled into the form of a cylinder. Each bandage of this type should consist of only one piece, free from wrinkles, seams, selvage, and any imperfections that may cause discomfort to the patient. Although there are various types of mechanical appliances used in winding bandages, it is essential that enlisted men be able to roll a bandage by hand.

e. The strips of bandage material should be folded at one extremity several times to form a small, firm cylinder. This cylinder is held by its extremities with the index finger and thumb of the left hand. The free end of the bandage is held between the index finger and thumb of the right hand, close to the cylinder. With this hand, the bandage then is revolved around the cylinder which is held in the left hand, the free fingers of which aid in turning the cylindrical roll. The amount of tension exerted upon the free end will determine the firmness of the completed roller. A roller bandage consists of the free end or initial extremity, the body, and the terminal extremity in the center of the cylinder.

f. The length and width of bandages vary according to the purposes for which they are employed. The sizes most frequently used are 1 inch wide, 3 yards long, for the hand, fingers, and toes; 2 inches wide, 6 yards long, for head bandages; 2½ inches wide, 7 yards long, for extremities; 3 inches wide, 9 yards long, for thigh, groin, and trunk.

■ 32. RULES FOR BANDAGING.—*a.* In applying a roller bandage, the roll should be held in the right hand so that the loose end is on the bottom; the outside surface of the loose or initial end is next applied to and held on the part by the left hand; and the roll is then passed around the part by the right hand which controls the tension and application of the bandage. Two or three of the initial turns of a roller bandage should overlie each other in order to secure the bandage and keep it in place. In applying the turns of the bandage, it is often necessary to transfer the roll from one hand to the other.

b. Bandages should be applied evenly, firmly, and not too tightly. Excessive pressure may cause interference with the circulation and may lead to disastrous consequences. In bandaging an extremity, it is therefore advisable to leave the fingers or toes exposed in order that the circulation of these parts may be readily observed. It is likewise safer to apply a large number of turns of a bandage rather than to depend upon a few too firmly applied turns to secure a splint or dressing.

c. In applying a wet bandage, or one that may become wet in holding a wet dressing in place, it is necessary to allow for shrinkage. The turns of a bandage should completely cover the skin, as any uncovered areas of skin may become pinched between the turns with resulting discomfort.

d. Bandages should be applied in such a manner that skin surfaces are not brought in contact, as perspiration will cause excoriation and maceration of the skin.

e. In bandaging an extremity, it is advisable to include the whole member (arm and hand, leg and foot), except the fingers and toes, in order that uniform pressure may be maintained throughout. It is also desirable in bandaging a limb that the part be placed in the position it will occupy when the dressing is finally completed, as variations in flexion or exten-

sion of the part will cause changes in the pressure of certain parts of the bandage.

f. The initial turns of a bandage of an extremity (including spica bandages of the hip and shoulder) always should be applied securely, and when possible, around the part of the limb that has the smallest circumference. Thus in bandaging the arm or hand, the initial turns usually are applied around the wrist, and in bandaging the leg or foot, the initial turns are applied immediately above the ankle.

g. The final turns of a completed bandage usually are secured in the same manner as are the initial turns, by the employment of two or more overlying circular turns. As both edges of the final circular turn are necessarily exposed, they should be folded under to present a neat, cuff-like appearance. The terminal end of the completed bandage is turned under and secured to the final turns by either a safety pin or adhesive tape. When these are not available, the end of the bandage may be split lengthwise for several inches, and the two resulting tails secured around the part by tying.

h. When the turns of a bandage cross each other, as in the figure-of-eight, the spiral reverse, and the spica, the line of crossings should be straight, and if practicable, should be in the center line of the part bandaged, but the line of crossings should not be over a bony prominence. The exposed portions of the turns should be of approximately the same width.

i. In removing a bandage, it may be cut, preferably with bandage scissors. In doing so the operator should be careful to avoid interference with the underlying dressing and the affected area.

j. If the bandage is removed without cutting, its folds should be gathered up in first one hand and then the other as the bandage is unwound. This procedure will facilitate removal and the rewinding of the bandage, if that be desirable.

■ 33. APPLICATION OF BANDAGES AND THEIR USES.—*a. Circular bandage.*—After anchoring the initial turns of the bandage, a series of circular turns is made around the part. Each turn should overlie accurately the turn beneath it, neither ascending nor descending. This bandage is used for retention of dressings to a limited portion of an extremity, the

neck, or the head; compression to control venous hemorrhage and to promote venous stasis.

b. *Spiral bandage*.—After anchoring the initial turns, each turn is applied in a spiral direction in such a manner as to overlie one-third of the preceding turn. As usually applied to an extremity, the upper edge of each turn of an ascending spiral is tighter than the lower edge with resulting inequality of pressure. For this reason, many surgeons object to its use on an extremity. However, this apparent fault may be overcome to a great extent by applying the bandage in the manner described in paragraph 31. This bandage is used for retention of dressings of the arm, chest, and abdomen (fig. 29),



FIGURE 29.—Spiral bandage. (Owen.)

c. *Oblique bandage*.—A series of oblique turns is applied around a part in such a manner as to have an uncovered area between turns. The width of the uncovered area should be uniform throughout. This bandage is used for retention of thick dressings or of temporary dressings which require frequent removal.

d. Recurrent bandage.—In applying this bandage, the roller, after securing the primary turns, is carried completely over a part to a point opposite its origin, and then reflected and brought back to the starting point where it is secured by one or more circular turns (fig. 30). In the recurrent bandage of

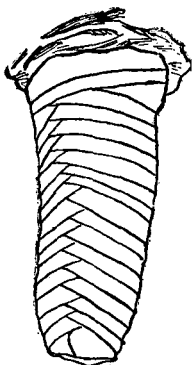

FIGURE 30.—Recurrent bandage of stump. (Wharton.)

the hand, the bandage is secured at the wrist, carried over the back of the hand, around the tips of the fingers, across the palm to the wrist. Held at this point by the disengaged hand of the operator, the bandage is carried across the palm around the tips of the fingers, across the back of the hand to the wrist, where it is held by the thumb of the operator's disengaged hand. Each turn overlies one-third of the preceding turn. The original turn over the fingers may cover the middle and ring fingers, with each succeeding turn applied alternately over the other fingers first to one side and then to the other of the middle finger; or the original turn over the fingers may be applied over the first finger or over the little finger, each subsequent turn covering a portion of the remaining exposed fingers. The reflected portion of the bandage at the wrist is then secured by a number of circular turns. It is customary to complete such a bandage with a figure-of-eight bandage enclosing the entire hand.

e. Figure-of-eight bandage.—This is undoubtedly the most useful bandage and with its various modifications, probably

is employed more frequently than any other type. The enlisted man should perfect himself in the application of this bandage, as, with a few exceptions, the majority of bandages are applied on the principle of the figure-of-eight. Its name is derived from the fact that the turns are applied so as to form a figure 8. Although it is employed commonly in bandages of the joints (elbow, knee, and ankle), it frequently is applied in bandaging the neck and axilla, head and neck, and head and jaw. If properly applied, it may be used very successfully in bandaging the extremities.

(1) *Hand and wrist*.—After anchoring the bandage with two circular turns about the wrist, the bandage is carried across the back of the hand to the base of the fingers, then into the palm, across the palm to the back of the hand, and across the back of the hand to the starting point at the wrist, where one circular turn is made. This general course is followed with several similar turns, each one overlying about one-third of the preceding turn on the back of the hand. After a sufficient number of turns has been made, the bandage is terminated with a circular turn around the wrist. This bandage is used for retention of dressings on the back of the hand or in the palm (fig. 31).

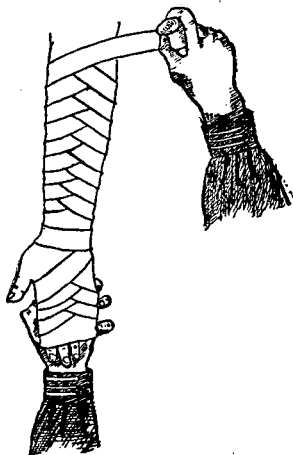

FIGURE 31.—Figure-of-eight bandage. (Wharton, modified.)

(2) *Forearm*.—This bandage may be the continuation of the figure-of-eight of the wrist and hand, or may be started with primary circular turns of the wrist. This bandage is carried obliquely upward across the back of the forearm and around the arm in its natural course, where it forms the upper loop of the figure-of-eight. The bandage then is carried in an oblique direction downward across the back of the arm, where it crosses the upward turn of the bandage. Then it is carried around the lower end of the forearm to complete the lower loop of the figure-of-eight. The same process is repeated several times until the elbow is reached, each turn overlapping the upper one-half or three-quarters of the preceding turn. The bandage is terminated finally with two or more circular turns at the elbow. The final circular turn, with both upper and lower edges of the bandage folded under, should be applied firmly and should present a neat, cuff-like appearance at the upper end of the completed bandage (fig. 31). During the application of this bandage, there is always considerable slack in one edge of the bandage where it is carried around the arm. As the bandaging proceeds, however, these loose edges are covered by the ascending turns of the bandage. It is used for retention of dressings and covering of splints.

(3) *Elbow*.—With the elbow in the desired position, the initial end is secured by circular turns around the forearm just below the elbow. The bandage then is carried upward over the flexure of the elbow in an oblique direction and passed around the arm just above the elbow, where a circular turn is made, and then is carried obliquely downward across the flexure and passed around the forearm. This procedure is repeated, with each turn overlying the preceding turn, the turns on the forearm ascending and those on the arm descending until the entire joint is covered. The final turn is a circular one around the elbow joint itself. This bandage may be started with a circular turn around the joint followed by figure-of-eight turns covering the upper part of the forearm and the lower part of the arm. It is used for retention of dressings around the elbow joint.

f. Spiral reverse bandage of the arm.—This bandage is in reality a modification of the figure-of-eight, in that only

the lower loop or one-half of the figure-of-eight is completed. After anchoring the primary turns, the bandage is carried obliquely upward on the back of the arm. When this turn reaches the center line of the arm, the thumb of the disengaged (usually the left) hand is placed upon the body of the bandage to hold it securely in place upon the arm. The operator then unrolls about 5 or 6 inches of bandage which is held slack and is folded upon itself by changing the position of the hand holding the roller from supination to pronation. The bandage then is carried obliquely downward across the arm to a point opposite that from which the ascending turn started. It then is tightened slightly to conform to the part accurately, then is carried around the limb and the procedure is repeated. It is necessary to retain the thumb upon the point of reverse until the succeeding turn reaches that point. As in the figure-of-eight, each turn should overlie at least one-third of the preceding turn and the reverses should be in a straight line (fig. 32).

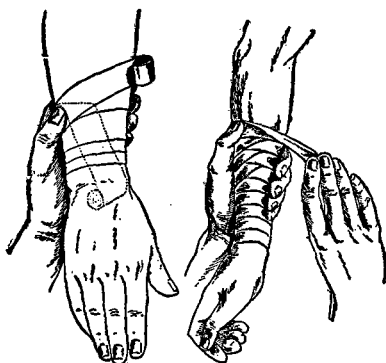

FIGURE 32.—Spiral reverse. (Eliason.)

g. Complete bandage of the hand.—After securing the initial turns around the wrist, a recurrent bandage of the hand is applied. The bandage then is carried obliquely across the back of the hand to the tip of the index finger. A circular turn is made around the ends of the fingers. The

fingers and hand then are covered by a figure-of-eight or spiral reverse bandage which finally is completed by two or more circular turns around the wrist. This bandage may or may not be applied to include the thumb. It is used for retention of dressings of the hand (fig. 33).



FIGURE 33.—Complete bandage of hand. (Wharton.)

h. Demigauntlet bandage.—Using a 1-inch bandage, secure the initial turns at the wrist and carry the bandage across the back of the hand to the base of the thumb, around the thumb, across the back of the hand to the wrist, where a circular turn is made. The same procedure is repeated successively for each finger and the bandage finally terminated with a circular turn around the wrist. It is used for retention of dressings on back of hand (fig. 34).

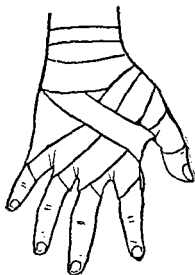

FIGURE 34.—Demigauntlet of hand. (Wharton.)

i. Gauntlet bandage.—The demigauntlet bandage may be extended to include the entire thumb and fingers with either

simple spiral turns or spiral reverse turns of each digit (fig. 35).



FIGURE 35.—Gauntlet bandage of hand. (Wharton.)

j. Spica bandage of right shoulder (ascending).—After securing the initial end by two circular turns around the arm opposite the axillary fold, the bandage is carried diagonally across the arm and front of the chest to the axilla of the opposite side, then around the back of the chest, across the arm, and across the upward turn to the point of origin. After carrying the bandage around the arm, this procedure is re-

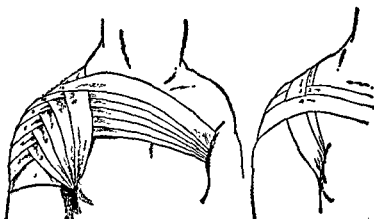

FIGURE 36.—Spica and spica loops of the shoulder. (Eliason.)

peated, each turn overlying about two-thirds of the preceding turn until the entire shoulder is covered. The turn should cross in a straight line extending up the center line of the arm over the point of the shoulder. Likewise the turns across the chest and back should overlap each other uniformly, and the turns in the opposite axilla should overlap each other exactly. The bandage may be secured by either a pin or adhesive tape. It is used for retention of dressings of shoulder and axilla and of shoulder cap (fig. 36).

k. Bandages of the lower extremity.—The bandages described in the preceding paragraphs may be applied to the corresponding parts of the lower extremity. However, descriptions of a few of the special bandages of the lower extremity are as follows:

(1) *Spica bandage of the groin (ascending).*—After securing the initial turns around the upper part of the thigh just below the groin, the bandage is carried obliquely upward

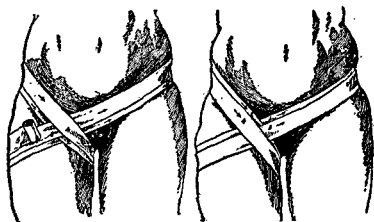

FIGURE 37.—Ascending and descending spica. (Eliason.)

across the lower abdomen to the ilium crest of the opposite side, transversely across the back, then downward obliquely across the front of the thigh, across the upward turn of the bandage, and around the thigh to the point of origin thus completing a figure-of-eight. This is repeated several times until the entire groin is covered, each turn overlying about two-thirds of the preceding turn. The same care in regard to the line of crossings of the turns and to the uniform overlapping of the bandage on the abdomen should be observed, as is noted in the description of the spica bandage of the shoulder. It is used for retention of dressings in region of the groin (fig. 37).

(2) *Spica bandage of the foot.*—The initial end is secured by two circular turns around the leg just above the ankle. The bandage then is carried across the dorsum of the foot to the base of the toes where a circular turn is made around the foot. After two or three spiral reverse turns are made, the bandage is carried across the dorsum of the foot, backward alongside of the heel, around the heel, forward along the other side of the heel across the preceding upward turn on the dorsum of the foot, and around the foot to the starting

point of the turn. This process is repeated, the turns gradually ascending on both the foot and the heel, the crossings of bandage being in the midline of the dorsum of the foot. The bandage finally is carried upward around the ankle and secured by two or more circular turns at its original starting point. It is possible to apply this bandage without the use of the spiral reverse turns by employing the figure-of-eight throughout. It is used for retention of dressings on the foot and support for sprained ankle (fig. 38).

(3) *Bandage of foot, not covering the heel.*—After securing the initial end by two circular turns around the leg just above the ankle, the bandage is carried obliquely across the dorsum

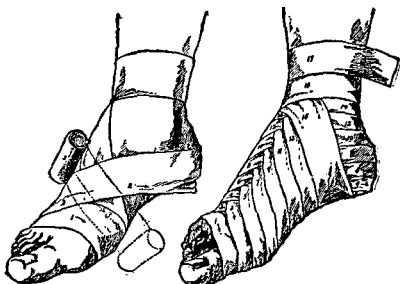

FIGURE 38.—Spica of the foot; first step and completed. (Eliason.)

of the foot to the base of the toes where a circular turn is made around the foot. The bandage is carried up the foot by a few spiral reverse turns crossings in the center line, and then applied as a figure-of-eight around the ankle and instep. The bandage may be terminated just above the ankle or be extended up the leg as far as may be necessary. It is frequently practicable to apply this bandage without employing the spiral reverse turns, the figures-of-eight being applied following the circular turns at the base of the toes. It is used for retention of dressings of foot. This bandage usually is employed in application of bandages covering the entire leg.

1. *Special bandages.*—(1) *Velpeau bandage.*—The fingers of the affected side are placed upon the opposite shoulder, a pad placed in the axilla, and the skin surfaces separated by sheet wadding. Place the initial end of the bandage on the shoulder

blade of the sound side, carry the bandage across the outer portion of the affected shoulder, downward over the outer and posterior surface of the flexed arm, behind the point of the elbow, obliquely across the back of the forearm and chest to the opposite axilla, and around to the point of origin. After repeating this turn once, the bandage is carried from the point of origin across the back and side of chest, in front of the flexed elbow and transversely across the front of the chest. Then it is carried around the other side of the chest, diagonally across the back to the affected shoulder. The first turn then is repeated, followed by a second circular turn around the chest and flexed arm. Each vertical turn over the shoulder overlaps two-thirds of the preceding turn, ascending from the outer part of the shoulder to the neck and from the upper posterior surface of the arm inward toward the point of the elbow. Each transverse turn also overlies one-third of the preceding turn. These transverse turns are continued until the last turn covers the wrist. The bandage is finally secured with pins, both where it ends and at various points where the turns of the bandage cross each other. (The initial turns of this bandage may be secured by circular turns around the chest under the arm of the affected side.) It is used for fixation of arm in treatment of fractured clavicle and fixation of humerus after reduction of dislocated shoulder joint (fig. 39).

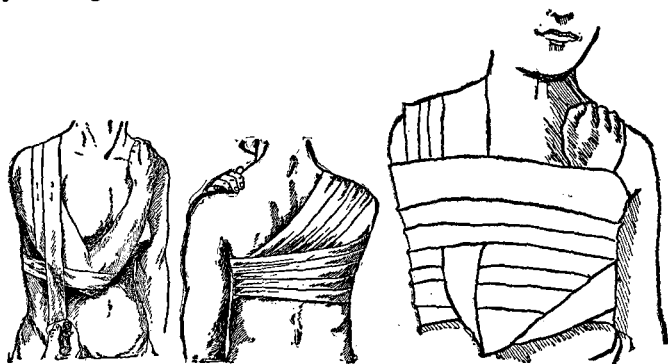

FIGURE 39.—Velpeau bandage; start (Eliason) posterior view (Eliason) and completed (Wharton).

(2) *Barton bandage*.—With the initial end of the bandage applied to the head just behind the right mastoid process, the bandage is carried under the bony prominence at the back of the head, upward and forward back of the left ear, obliquely across the top of the head, downward in front of the right ear, under the chin, upward in front of left ear, obliquely across the top of the head, crossing the first turn in the midline of the head, thence backward and downward to the point of origin behind the right mastoid. Then it is carried around the back of the head under the left ear, around the front of the chin, under the right ear to the point of origin. This procedure is repeated several times, each turn exactly overlying the preceding turn. The bandage is secured with a pin or strip of adhesive tape, and either a pin or adhesive may be applied at the crossing on top of the head. It is used for fracture of lower jaw and retention of dressings of chin (fig. 40).



FIGURE 40.—Barton bandage. (Wharton.)

(3) *Recurrent bandage of head*.—The initial turns are applied around the head, passing around the nape of the neck, above each ear and around the forehead. When the bandage has reached the center of the forehead on the third turn, its free margin is held by a finger of the left hand and the bandage is reversed and carried over the top of the head in the center line to the nape of the neck. With an assistant holding the bandage at the latter point, it is reflected forward over the top of the head covering the right half of the pre-

ceding turn. When it reaches the forehead in the midline, it again is reflected over the top of the head, overlying the left half of the first turn. At the nape of the neck in the center line, it is again reflected and carried forward overlying the outer half of the second turn. This process is repeated until the entire head is covered, the turns alternating to the right and left of the center line. The bandage finally is completed by several circular turns overlying the original turns and fixing the ends of antero-posterior turns at the nape of the neck and on the forehead, where pins should be applied to provide additional security. Uses: Retention of dressings of wounds of the scalp, of fractures and operative wounds of the skull (fig. 41). This bandage may be applied with the turns over the head in a transverse direction extending from ear to ear.



FIGURE 41.—Recurrent turns. (Ellason.)

(4) *Crossed bandage of one eye.*—The initial extremity is secured by a circular turn around the head below the bony prominence at the back, above both ears and across the forehead. The bandage then is carried from the back of the head, below the ear, obliquely across the outer part of the cheek to the base of the nose at its junction with the forehead, over the opposite side of the head and downward behind the mastoid process. A circular turn then is carried around the head, overlying exactly the original turns. A second turn under the ear and across the face and head then is applied, overlapping the upper two-thirds of the preceding turn. These alternating turns are repeated until the eye (and if

more comfortable, the ear on the same side) is completely covered. The bandage is completed with a final circular turn around the head. It is used for retention of dressings of the eye (fig. 42).

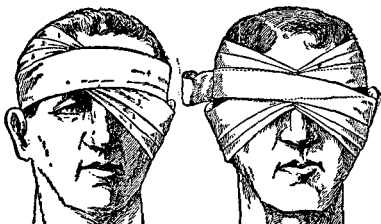

FIGURE 42.—Crossed bandage (figure-of-eight) of one eye and of both eyes. (Eliason.)

(5) *Crossed bandage of both eyes.*—The initial turns are applied as for one eye and the bandage carried forward below the right ear, diagonally upward across the cheek to the base of the nose and over the opposite side of the head above the left ear, and downward behind the left mastoid process. Then a circular turn is applied. When the roller reaches the back of the head below the bony prominence, it is carried obliquely forward and slightly upward over the right ear across the forehead and downward over the left eye, the lower margin of the bandage crossing the previous turn at the junction of the nose with the forehead. The bandage then is carried across the left cheek below the left ear and backward to the nape of the neck. Then a circular turn is made, followed by a repetition of the previous turns across the eyes, each circular turn accurately covering its predecessor and each oblique turn overlying the upper one-half of the preceding turn until both eyes are completely covered. The ears may or may not be included in the bandage, which is completed by two circular turns around the head. Pins are placed at the intersections of the bandage (fig. 42).

(6) *Sayre's dressing.*—This consists of two strips of adhesive plaster 3 inches wide and 2 yards long. Two circular turns of a flannel bandage 4 inches wide are applied to the arm of the affected side just below the axillary fold. The end of one adhesive strip is looped around the arm (overlying the

flannel bandage) and pinned, with the loop sufficiently large not to constrict the arm. With the arm drawn upward and backward, the strip of plaster is carried across the back and around the opposite side of the chest. It may end here or be carried completely around the chest. The hand of the injured side now is placed as near as possible to the shoulder of the sound side, the skin surfaces being separated by sheet wadding. The end of the second strip is applied over the scapula of the affected side (some surgeons start this strip at the top of the posterior surface of the arm of the affected side; others apply the initial end of this strip on the shoulder of the sound side) and is carried downward on the posterior surface of the arm of the affected side, under the point of the elbow, diagonally across the chest on the posterior surface of the forearm and hand over the sound shoulder down the back where it joins the first strip of plaster. A small hole is cut in this strip to receive the point of the elbow, which must be protected by a layer of cotton or sheet wadding. Then the entire dressing is covered with a Velpeau bandage. It is used for treatment of fractures of the clavicle (fig. 43).

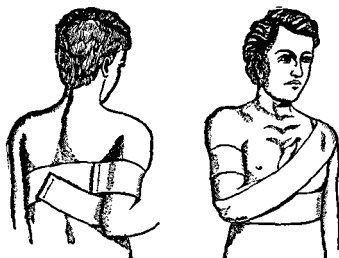

FIGURE 43.—Sayre's dressing for fracture of the clavicle, showing application of first and second strips. (Wharton.)

(7) *T-bandage*.—This bandage consists of a horizontal bandage to which is attached, about its middle, a vertical bandage of approximately one-half the length of the horizontal bandage. The horizontal portion is employed to secure the bandage to the body, the vertical portion being used to retain dressings. This bandage is very useful in retaining dressings about the perineum and anal region. When used

for this purpose, the horizontal band is applied around the abdomen above the iliac crests in such manner that the vertical portion is placed exactly in the midline of the back directly over the spine. The vertical portion then is brought forward between the thighs and secured to the horizontal portion in front of the abdomen. The vertical portion may be split longitudinally to form two strips of equal width.

(8) *Double T-bandage*.—This differs from the T-bandage in having two vertical strips instead of only one. The horizontal portion may be of any desired width. It frequently is used for the retention of dressings of the chest, breast, and abdomen. When so employed, the two vertical strips are carried over the shoulders from the back to the front and secured by pins to the horizontal portion.

(9) *Tailed bandage*.—(a) The four-tailed bandage is made readily by splitting a strip of muslin or other material of the desired width, lengthwise, within a few inches of the center of the strip. This provides a bandage with a body and four tails.

(b) The many-tailed bandage is prepared in a similar manner, by splitting the muslin or other material into several strips, having a sufficiently large area in the center for the retention of dressings, etc. The number of tails on each side should be the same.

(10) *Plaster of paris bandage*.—These bandages are prepared by impregnating the meshes of crinoline with plaster of paris of the extra calcined, dental variety. A strip of crinoline about 3 or 4 inches wide and usually 4 or 5 yards long, is placed on a table. Plaster of paris then is dusted upon the strip and evenly rubbed into the meshes of the fabric. A very satisfactory method of preparing this bandage is by constructing a wooden box, 12 inches long, 6 inches wide, and 3 inches deep, and at each end, just above the bottom of the box, cutting a slit 5 inches long and $\frac{1}{8}$ to $\frac{1}{4}$ inch wide. The end of the bandage is drawn into the box through one slit across the bottom of the box and out of the box through the other slit. A sufficient quantity of the plaster of paris to cover the bandage with a layer of powder 1 inch deep is placed in the box. As the bandage is drawn through, plaster of paris is rubbed into the meshes with the

hand or preferably with a smooth piece of wood approximately 4 inches in length. The bandage may be loosely rolled into a cylinder as it emerges from the box. If the bandages are not to be used within a few hours, they should be wrapped in paper to prevent absorption of moisture.

(a) *Application.*—The part to be encased in plaster of paris should be covered with a suitable bandage of soft material, preferably flannel. The bony prominences should be well protected with cotton. Care should be taken to remove all creases in the dressing and bandage.

Two rolls of the plaster of paris bandage are placed in warm water. When bubbles cease to arise from the bandage one roll is removed from the water, the excess water being expressed by grasping the roll at its two ends and exerting pressure with the hands. This method prevents the loss of a considerable amount of plaster through the ends of the roll.

NOTE.—As soon as a bandage is removed from the water replace it with another bandage.

The bandage should be applied rapidly and evenly to the limb. No special form of bandage is necessary as it is sufficient that the part be properly covered. The second bandage is applied as soon as the first has been completed. During the application of the bandage it should be rubbed with the hands in order to provide a smooth even surface. It also is desirable to rub some loose plaster into the dressing. When the final roller has been applied, the surface of the completed dressing should be rubbed evenly with liquid plaster prepared by addition of water to dry plaster until it has the consistency of thick cream. In many cases, such as compound fractures, it is frequently necessary to provide access to certain areas of the encased limb. After the bandage has partially set a "window" or trap may be cut in the bandage over the desired area. Removal of a plaster of paris bandage may be accomplished with the aid of a plaster saw. If none is available, the plaster may be softened with a small amount of peroxide of hydrogen, hydrochloric acid, or vinegar, and then may be cut with a knife.

(b) *Uses.*—This bandage is used for fixation of fractures; ambulant treatment of fractures; fixation and treatment of injuries and diseases of joints.

(11) *Starched bandage*.—This bandage may be obtained already prepared or it may be prepared in the following manner: Starch is mixed with cold water until a thin, creamy mixture results. This is heated to form a clear mucilaginous liquid. The part should be covered with a flannel bandage over which a gauze bandage is applied. The starch then is rubbed evenly into the meshes of the material. A second gauze bandage is applied and again treated with the starch mixture. This may be repeated until the desired thickness of the bandage is obtained. Bandages impregnated with starch may be moistened and applied wet to a part. This type of bandage is occasionally useful in the treatment of sprains of the thumb or fingers.

(12) *Triangular bandage*.—This bandage, also known as the handkerchief bandage, is used for the temporary or permanent dressing of wounds, fractures, dislocations, etc., and for slings. It is very valuable in first-aid work as it is quickly and easily applied, stays on well, and can be improvised from any kind of cloth, as a piece of a shirt, an old sheet, a large handkerchief such as the Navy uniform neckerchief, etc. Unbleached muslin is generally used in making triangular bandages, although linen, woolen, silk, etc., will answer the purpose. In making them, a square of material about 3 by 3 feet or slightly more is folded diagonally to make one bandage or may be cut along the fold to make two bandages. The long side of the triangle is called the "base," the point opposite the base is called the "apex," and the points at each end of the base are called the "ends" or "extremities". These bandages may be used either as a triangle or as a cravat, the latter being made from the triangle by bringing the apex to the base and folding it upon itself a sufficient number of times to obtain the width desired (fig. 44). The names of these bandages indicate the part of the body to which the base is applied, the location of the apex, and the shape. For example, in the fronto-occipital triangle the base of a triangular bandage is applied to the forehead and the apex is carried to the occiput, and in the mento-vertico-occipital cravat the middle of the base is placed under the chin and the ends carried over the vertex of the skull to the occiput.

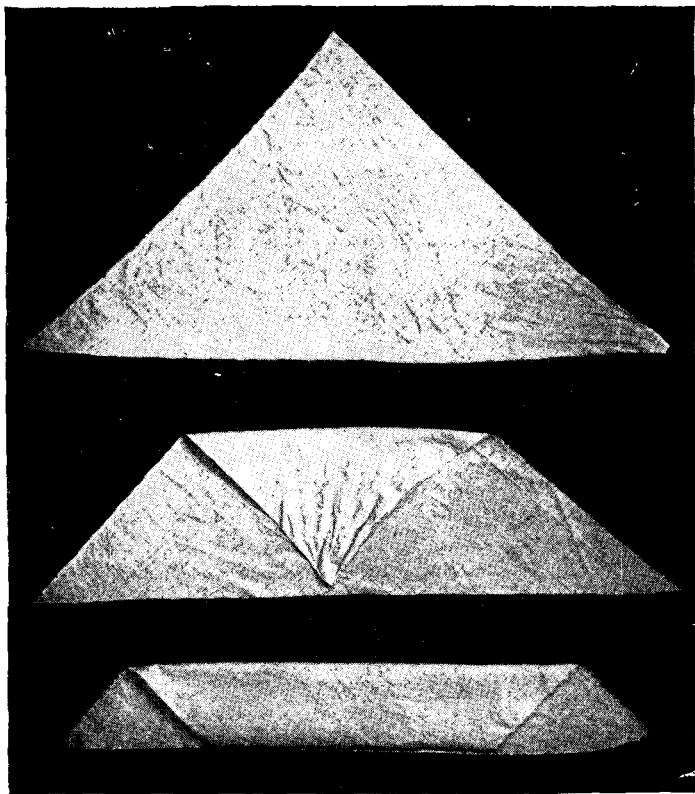

FIGURE 44.—Folding cravat from triangle.

A few of the more commonly used triangular bandages as follows:

(a) *Fronto-occipital triangle*.—Place the middle of the base of the triangle on the forehead so that the edge is just above the eyebrows and bring the apex backward over the head, allowing it to drop over the occiput. Bring the ends of the triangle around to the back of the head, above the ears, cross them over the apex at the occiput, and carry them

around to the forehead and there tie them in a square knot. Finally turn up the apex toward the top of the head and pin with a safety pin or turn up the apex and tuck it in behind the crossed part of the bandage. It is used to retain dressings on the forehead or scalp (fig. 45).

(b) *Triangle of chest or back.*—Drop the apex of the triangle over the shoulder on the injured side and bring the bandage down over the chest (or back) to the level desired and so that the middle of the base is directly below the shoulder. Carry the ends around the body and tie in a square knot on the back. Finally, bring the apex down on the back (or chest) and tie it in a square knot to one of the ends. It is used to retain dressings on burns or wounds of the chest or back (fig. 46).

(c) *Brachio-cervical triangle, or arm sling.*—The arm to be put in the sling should first be bent at the elbow so that the little finger is about a hand's breadth above the level of the elbow. Drop one end of the triangle over the shoulder on the uninjured side and let the bandage hang down over the chest with the base toward the hand and the apex toward the elbow. Slip the bandage between the body and the arm, carry the lower end up over the shoulder on the injured side, and tie the two ends together at either side of the neck, using a square knot. Draw the apex of the bandage toward the elbow until it is snug, bring it around the elbow to the front, and after folding back a little, fasten it to the front of the bandage with a safety pin. The lower end of the bandage may be passed between the arm and the body and under instead of over the injured shoulder before tying to the other end. The ends of the fingers should extend slightly beyond the base of the triangle (fig. 47).

(d) *Triangle of hand.*—Place the middle of the base of the triangle well up on the palmar surface of the wrist, carry the apex around the ends of the fingers and over the dorsum of the hand to the wrist or forearm, fold each half of the part at the sides of the hand back toward the opposite side of the wrist, cross the ends around the wrist, and tie in a square knot. It is used to retain dressings of considerable size on the hand (fig. 48).

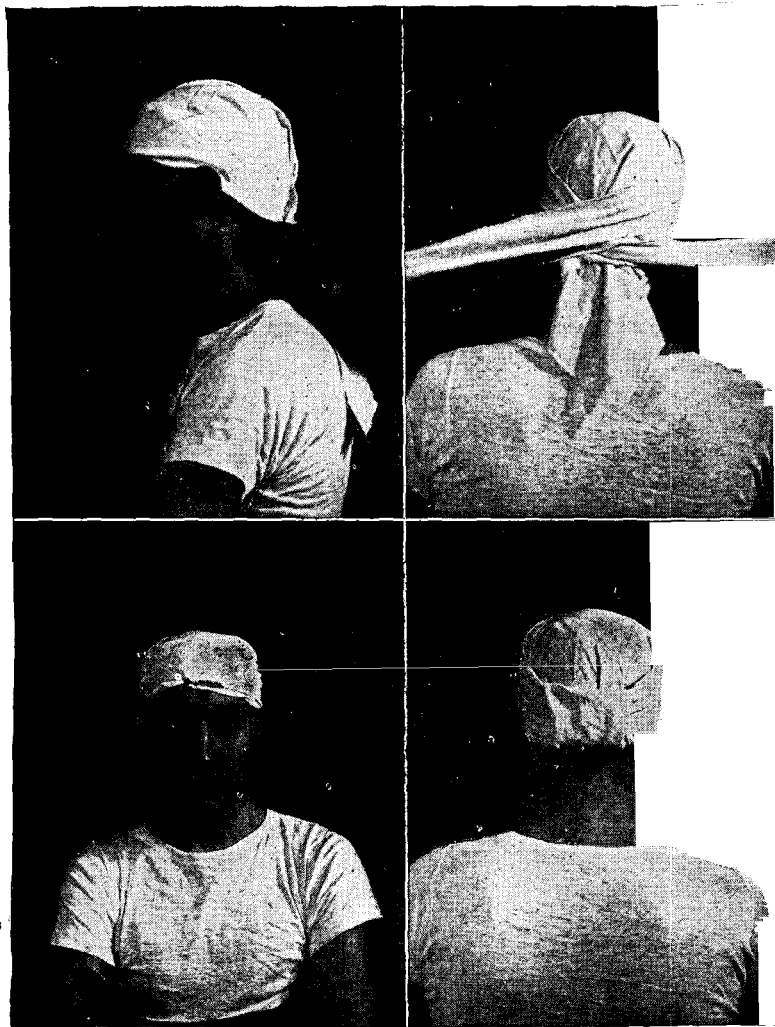

FIGURE 45.—Fronto-occipital triangle.

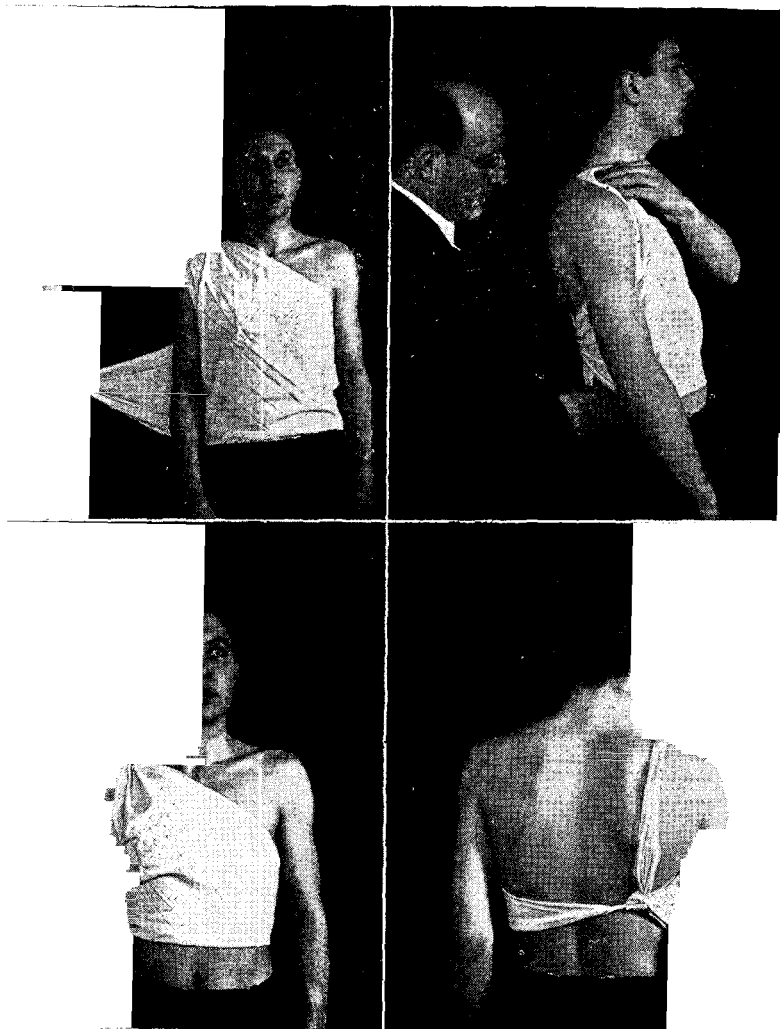

FIGURE 46.—Triangle of chest or back.

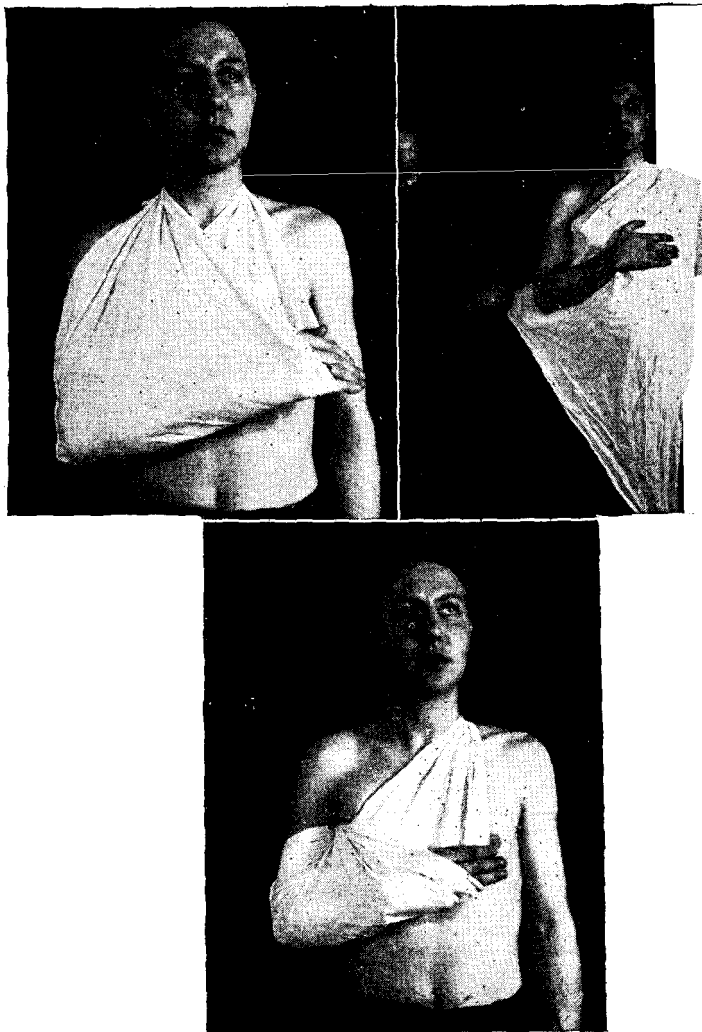

FIGURE 47.—Brachio-cervical triangle or arm sling showing lower end passing between arm and body.

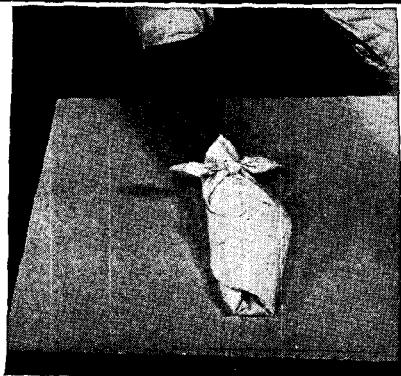
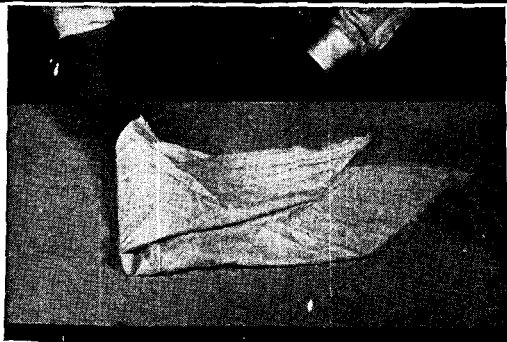
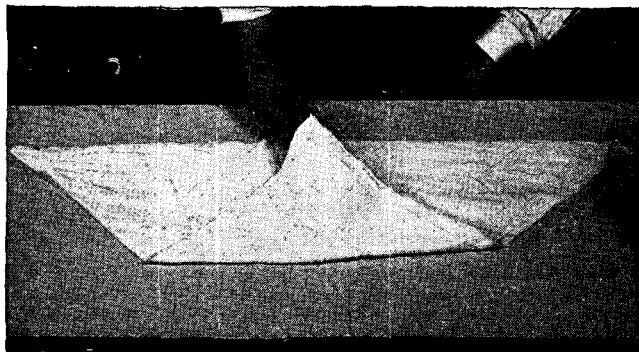

FIGURE 48.—Triangle of hand.

(e) *Triangle of foot*.—Place the middle of the base of the triangle on the ankle well above the heel, carry the apex around the ends of the toes and over the dorsum of the foot to the ankle, fold each half of the part at the sides of the foot back toward the opposite side of the ankle, cross the ends around the ankle, and tie in a square knot. It is used to retain dressings of considerable size on the foot (fig. 49).

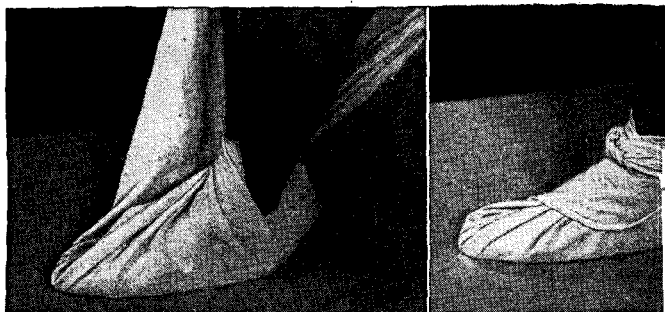

FIGURE 49.—Triangle of foot.

(f) *Gluteo-femoral triangle*.—To apply this bandage requires two bandages, one a triangle, the other a cravat. First fasten the cravat around the waist. Place the base of the triangle in the gluteo-femoral fold and carry the ends around the thigh to the front where they are tied with a square knot. The apex is then carried upward and passed under the cravat around the waist, turned down and fastened to the triangle with a safety pin. It is used to retain dressings on the buttock or hip (fig. 50).

(13) *Cravats*.—(a) *Mento-vertico-occipital cravat*.—After making a triangle into a cravat of the proper width, place the middle of the cravat under the chin, carry the ends upward in front of each ear to the vertex of the skull, crossing them there, and continuing downward to the occiput where they are tied in a square knot. Uses: To retain dressings on the chin, cheeks, and scalp, and as a temporary dressing to secure fixation of the parts in fracture or dislocation of the jaw (fig. 51).



FIGURE 50.—Gluteo-femoral triangle.



FIGURE 51.—Mento-vertico-occipital cravat.

(b) *Bis-axillary cravat*.—After making a triangle into a cravat of the proper width, place the middle of the cravat in the axilla, carry the ends upward to the top of the shoulder crossing them there and continuing across the back and chest respectively to the opposite axilla where they are tied in a square knot. It is used to retain dressings in the axilla or on the shoulder (fig. 52).



FIGURE 52.—Bis-axillary cravat.

(c) *Cravat of head or ear*.—After making a triangle into a cravat of the proper width, place the middle of the cravat over the point desired, carry the ends to the opposite side of the head, cross them, and bring them back to the starting point and tie with a square knot. Use: To apply pressure to control serious hemorrhage from wounds (fig. 53).

■ 34. DRESSINGS.—*a. Types*.—A dressing consists of everything used to cover or dress a wound. The pad put directly over the wound is called a “compress.” In ordinary emergency treatment, a wound dressing consists of a compress with bandage to hold it on. A dressing may be either dry or wet, aseptic or antiseptic.



FIGURE 53.—Cravat of head or ear.

(1) An *aseptic dressing* is one which is sterile, that is, with no bacteria on it.

(2) An *antiseptic dressing* is one which, in addition to being sterile, contains some substance for killing bacteria.

(3) A *wet dressing* generally is an antiseptic dressing and is used in wounds where infective inflammation is going on. Wet antiseptic dressings generally are made up of a layer of sterile gauze saturated with the antiseptic solution. A layer of sterile cotton is then applied, with some impervious material such as oiled silk put over the dressing to retain the moisture, and a bandage over all. The dressing must be kept wet with the antiseptic solution, either by frequent changing or by having perforated rubber tubes between the gauze and cotton through which the dressing can be periodically moistened with the antiseptic solution.

(4) A *dry dressing* is used to cover a recent wound which is considered to be free from infection.

b. *Purpose.*—The purpose of a wound dressing is to stop hemorrhage, to prevent introduction of bacteria, and to prevent further injury to the wound.

c. Types in first-aid packet.—The Army supplies two first-aid packets, one small and one large, which are hermetically sealed tin cans containing dry sterile dressings. (See figs. 54–57 incl.). All these dressings consist of a sterile gauze compress with bandages attached.

d. Preparation of wound for dressing.—(1) *General.*—Any piece of cloth, such as gauze, cotton, linen, muslin, or a handkerchief, provided it is rendered sterile, is suitable for a compress in case of emergency. The most vital point about material used as a compress of a wound is that, before it is applied to a wound, it should be rendered sterile. The part of the dressing which is to come in contact with the wound must not be touched with any part of the body or anything else except sterile instruments before its application to the wound. In an emergency, material to be used in a wound dressing may be sterilized by boiling it for 10 minutes.

(2) *Procedures.*—When a patient can be brought under the care of a medical officer in the near future, the procedure necessary in the first-aid treatment in the case of ordinary wounds is to stop the hemorrhage, treat the shock, and apply a sterile dressing to the wound. If a medical officer is not available, the wound must be further treated as described below.

(a) In treating a freshly made wound, the following procedure is recommended:

1. Cleanse the hands as thoroughly as possible by a thorough scrubbing with soap and hot water, followed, if possible, by immersion in hot 1–2000 bichloride of mercury solution and then 70 per cent alcohol.
2. Sterilize all instruments to be used in removing foreign bodies such as dirt, glass, splinters, or for shoving the skin about the wounds.
3. If there is bleeding, arrest the hemorrhage.
4. If there is grease in or about the wound, remove it with turpentine or gasoline.
5. Remove all foreign particles with sterile forceps.
6. Apply tincture of iodine to all parts of wound and the skin about the wound for a distance of about $\frac{1}{2}$ inch beyond the wound edges. After the skin

has been well dried, the wound edges are brought together and a dry dressing applied.

7. There is no substance which should be used by the first-aid man to wash a wound; more dirt is washed in than out, and ordinary water is dangerous since it is not sterile. Strong antiseptics, such as bichloride of mercury or phenol, will destroy the cells of the body which dispose of the pus bacteria before they kill the latter. Peroxide of hydrogen is not strong enough to kill all bacteria and in large or deep wounds it washes some of these bacteria to uninfected parts which then become infected. *Tincture of iodine is the only substance to be used in an ordinary fresh wound by the first-aid man, aside from benzine and gasoline to cut grease, if present.*

(b) The manner in which a wound showing evidence of infective inflammation is treated is as follows:

1. Elevate the part.
2. Put it at rest.
3. Remove foreign bodies, if present.
4. Remove sufficient sutures, if present, to obtain good drainage.
5. Insert drain.
6. Apply a wet antiseptic dressing (fig. 58).
7. Treat the constitutional symptoms.

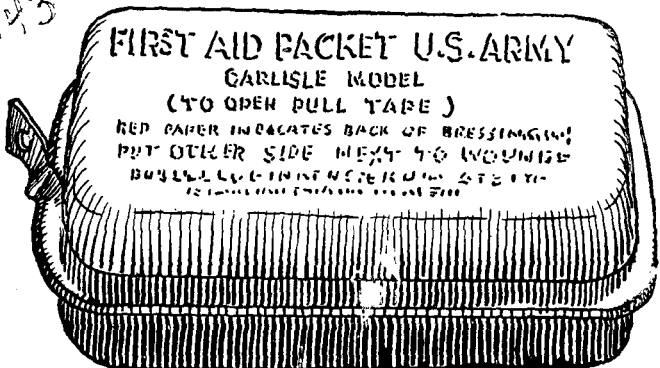

FIGURE 54.—First-aid packet, U. S. Army.

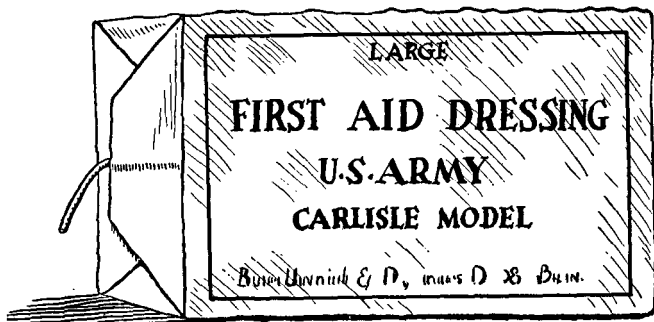

FIGURE 56.—First-aid dressing, large.

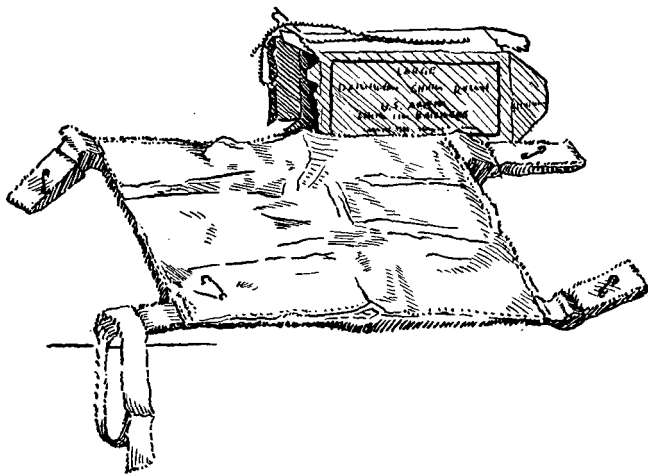

FIGURE 57.—First-aid dressing, large, open.

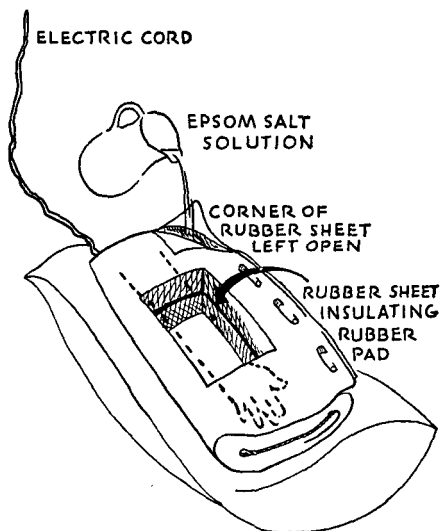

FIGURE 58.—Type of wet dressing.

APPENDIX

BIBLIOGRAPHY

**Figures 16 and 17. Courtesy of The Tower Company, Inc.,
Seattle, Wash.**

**Figures 27 and 28. Courtesy of Dr. W. Gayle Crutchfield in
J. Bone and Joint Surgery, July 1938.**

INDEX

	Paragraph	Page
Apparatus:		
Extension, Steinmann-----	16	29
Wire-----	18	30
Attachments, Pierson-----	20	32
Balkan frame-----	14	22
Bandages and dressings-----	1, 31	1, 52
Application and use-----	33	55
Bandaging, rules for-----	32	54
Casts:		
Body, hyperextension, pipe frame and ham- mock for-----	28	46
Plaster-----	27	45
Dislocations, cervical spine-----	30	50
Dressings and bandages-----	1, 31, 32, 34	1, 52, 54, 81
Fractures:		
Cervical spine-----	30	50
Clavicle, T-splint for-----	23	38
Compression, spine-----	29	49
Definitive treatment of-----	13	21
Major, lower extremities, immobilization for transportation-----	6	9
Proximal and distal, skeletal fixation-----	19	30
Spinal, emergency treatment and transporta- tion-----	7	12
Splinting for transportation-----	2	2
Hammock and pipe frame for hyperextension body cast-----	28	46
Immobilization for transportation, major lower extremity fractures-----	6	9
Pierson attachment-----	20	32
Pipe frame and hammock for hyperextension body cast-----	28	46
Plaster casts-----	27	45
Plaster of paris-----	26	44
Shock, traumatic, prevention and early treatment-----	11	18
Skeletal fixation, proximal and distal fractures---	19	30
Skeletal suspension and traction-----	17	29
Skin traction-----	15	27
Splinting fractures for transportation-----	2	2

INDEX

Splints:	Paragraph	Page
Aeroplane or abduction-----	24	40
Basswood -----	10, 25	18, 42
Cabot -----	21	35
Leg and thigh, half-ring, hinged, army-----	3	2
Straps, adjustable traction-----	4	4
Supports and footrests for-----	5	4
T, for fractured clavicle-----	23	38
Thomas, arm-hinged-----	9	15
Wire ladder-----	8	14
Wrist, aluminum cock-up-----	22	37
Splints, appliances, and bandages, purpose and scope of manual on-----	1	1
Steinmann extension apparatus-----	16	29
Traction and suspension, skeletal-----	17	29

